

**Carl von Ossietzky  
Universität Oldenburg**

**Bachelorstudiengang Biologie**

**Bachelorarbeit**

**A bit of black and white – a methodical study about the emergence of  
Culicoides (Diptera: Ceratopogonidae)**

**vorgelegt von Felix Kroischke**

**Betreuende Gutachterin: Prof. Dr. Ellen Kiel**

**Zweiter Gutachter: Dr. Wilko Ahrichs**

**Oldenburg, 21.11.2014**

# Content

|   |    |
|---|----|
| Zusammenfassung.....  | 2  |
| Abstract .....  | 2  |
| 1 Introduction.....   | 3  |
| 1.1 <i>Culicoides</i> and their importance in Europe .....              | 3  |
| 1.2 European indigene <i>Culicoides</i> species as vectors .....        | 4  |
| 1.3 Emergence traps as a way to examine <i>Culicoides</i> ecology ..... | 4  |
| 2 Material and Methods.....   | 6  |
| 2.1 Collection of cow pat samples .....                                 | 6  |
| 2.2 The different traps .....   | 7  |
| 2.3 Setup of the experiment .....                                       | 10 |
| 2.4 Measurement of the environmental parameters.....                    | 11 |
| 2.5 Sampling of <i>Culicoides</i> .....                                 | 13 |
| 2.6 Determination of the found individuals.....                         | 14 |
| 2.7 Statistical analysis .....  | 14 |
| 3 Results .....   | 17 |
| 3.1 Light intensity outside the eclectors and length of day .....       | 17 |
| 3.2 Light intensity inside the eclectors .....                          | 17 |
| 3.3 Temperature outside the eclectors .....                             | 19 |
| 3.4 Temperature inside the cow pat samples.....                         | 19 |
| 3.5 Temperature at the top of the eclectors .....                       | 21 |
| 3.6 Temperature at the side .....                                       | 22 |
| 3.7 Relative humidity outside the eclectors and rainfall .....          | 25 |
| 3.8 Relative humidity inside the eclectors .....                        | 25 |
| 3.9 Atmospheric pressure .....  | 27 |
| 3.10 Wind speed .....   | 28 |
| 3.11 General catch .....  | 29 |
| 3.12 Catch per type, shape and color .....                              | 30 |
| 4 Discussion .....  | 33 |
| 4.1 The forming of a specific microclimate inside the eclectors.....    | 33 |
| 4.2 The emergence of <i>C. chiopterus</i> and <i>C. dewulfi</i> .....   | 33 |
| 4.3 Differences between the types.....                                  | 35 |
| 4.4 Conclusions and suggestions for further studies .....               | 36 |
| 5 References .....  | 37 |
| Acknowledgements.....   | 39 |

The entire material that belongs to this thesis can be found on the attached DVD. It includes raw data, additional charts and figures as well as photos and pictures.

## Zusammenfassung

Obwohl seit dem Ausbruch der Blauzungenkrankheit im Jahr 2006 das wissenschaftliche Interesse an *Culicoides* stark gestiegen ist, bleibt deren Ökologie noch vielfach unklar. Schlupffallen, die zur Ergänzung des bestehenden Wissens genutzt werden könnten, existieren bisher in verschiedenen Bauarten, die sich in Material, Farbe oder Form unterscheiden. Standards fehlen ebenso wie Untersuchungen zum Einfluss unterschiedlicher Bauarten auf den Schlupf. Im Rahmen dieser Bachelorarbeit wurde über ein methodisches Feldexperiment ein Vergleich zwischen Schlupffallen verschiedener Farbe (schwarz / weiß) und Form (kastenförmig / trichterförmig) durchgeführt. Als Substrat dienten Kuhfladen. Zusätzlich wurden Klimadaten innerhalb und außerhalb der Fallen erfasst, um Beobachtungen interpretieren zu können. Es konnte festgestellt werden, dass die schwarzen Fallen einen signifikant höheren Fangerfolg zeigten ( $p < 0.05$ ). Die Form der Fallen war hingegen ohne Bedeutung. Die Temperatur hatte einen erkennbaren Einfluss auf die Entwicklung der Emergenz während des Experiments. Außerdem konnte das Entstehen eines spezifisches Mikroklimas in allen Fallen beobachtet werden.

## Abstract

Although the scientific interest in *Culicoides* raised after the Bluetongue emergence in 2006 their ecology remains widely unknown. Emergence traps that could be used to improve the existing knowledge currently exist in different designs, varying in material, color or shape. General standards are still missing as well as studies about the effect of the different designs on the emergence. In this thesis, a methodical field experiment was conducted to compare emergence traps that differ in color (black / white) and shape (box / funnel). Thereby cow pats were used as substrate. Additionally, climate data was measured inside and outside the eclectors to make an interpretation of observations possible. It was found that the black eclectors caught a significantly higher amount of *Culicoides* ( $p < 0.05$ ). However, the shape of the traps was without importance. The temperature had a remarkable effect on the development of the emergence during the experiment. Additionally, it was possible to observe the forming of a specific microclimate inside all eclectors.

# 1 Introduction

## 1.1 *Culicoides* and their importance in Europe

*Culicoides* are tiny, haematophagous insects that belong to the Ceratopogonidae-family. They occur in nearly every region of the world except Antarctica and New Zealand (Mellor, Boorman & Baylis 2000). The “gnats”, “no-see-ums”, “punkies” or “sand flies”, how they are commonly called, have always been annoying for explorers, residents, tourists or livestock (Dukes & Axtell 1976; Blanton & Wirth 1979; European Food Safety Authority 2007). They can easily penetrate conventional mesh window screens due to their body size of only 1-3 mm and can rapidly reach high abundances under suitable climatic conditions (Mellor *et al.* 2000). More importantly, *Culicoides* can transmit arboviruses, bacteria, protozoa and helminth parasites to humans and animals (Carpenter *et al.* 2013). In the last years, three of the arbovirus-driven diseases became important for Northern Europe: The Bluetongue disease (BT), the African horse sickness (AHS) and the novel Schmallenberg-Virus (SBV) (Lievaart-Peterson *et al.* 2012; Koenraadt *et al.* 2014).

Until 1998, BT was regarded as “exotic” in the whole EU (Saegerman, Berkvens & Mellor 2008), it was never reported in Northern Europe until August 2006 (Mehlhorn *et al.* 2007; Toussaint *et al.* 2007). In this month, BT broke out in Belgium, France, Germany and the Netherlands. The virus overwintered and reemerged in the next year with an increased number of cases (Hoffmann *et al.* 2008). After the virus spread to the United Kingdom, Switzerland, the Czech Republic, Denmark, and Spain, it could finally be stopped by the use of mass vaccination campaigns (Wilson *et al.* 2007; Saegerman *et al.* 2008; Conraths *et al.* 2009). The economic damage caused by BT was enormous: about 254 million Euros of financial losses accumulated in Germany alone until the end of 2010 (Conraths *et al.* 2012). In the Netherlands the financial losses were 237-248 million Euros until the end of 2008 (Velthuis *et al.* 2010). The Schmallenberg-virus, an until 2011 unknown arbovirus spread similar to BT rapidly from Germany to adjacent countries and even reached Norway in 2012 (Lievaart-Peterson *et al.* 2012; Doceul *et al.* 2013). At the moment, the economic damage of this disease cannot be estimated certainly due to the fact that it affects livestock pregnancy and therefore the following generations (Doceul *et al.* 2013). The African horse sickness is a threat that fortunately has not occurred in northern Europe to date. Nevertheless it is known that AHS uses the same vectors as BT

and SBV so that an outbreak could endanger horse rich countries like the Netherlands – with devastating effects due to mortality rates up to 90 % in livestock (Mellor & Hamblin 2004; Backer & Nodelijk 2011).

## **1.2 European indigene *Culicoides* species as vectors**

After BT broke out in 2006 it soon became apparent that the BT-virus was not introduced along with invasive animals. Known vector species like the African *C. imicola* (Kieffer, 1913) could not be found whereas the virus was detected in indigene species (Mehlhorn *et al.* 2008b, 2009a b; Casati *et al.* 2009). Because the species of Northern Europe were inconsiderable up to that time there was only small knowledge about them. As a result there was a lack of effective control measures and prediction abilities.

Meanwhile, the abundance of *Culicoides* was examined in several countries. The morphologic, molecular and field methods were improved. Several control measures were discussed and tested like the use of insecticides (Mehlhorn *et al.* 2008a; Schmahl *et al.* 2009), fungi (Ansari *et al.* 2011) or the protective stabling of livestock (Carpenter, Mellor & Torr 2008). Nevertheless, the knowledge about *Culicoides* ecology remains fragmentary.

## **1.3 Emergence traps as a way to examine *Culicoides* ecology**

One way to improve the knowledge about the ecology of insects are emergence traps, also called “eclectors”. Unlike the usually freestanding light traps, eclectors are set directly on the surface of a breeding substrates or they enclose it entirely. Every insect that emerges from the substrate is thus trapped inside the eclector and can be collected, e.g. by utilizing the phototaxis of many insects to bait them into collection containers. Emergence traps make it possible to identify important breeding factors under field conditions, providing essential information about the ecology of immature stages of *Culicoides* species (Meiswinkel, Venter & Nevill 2004). This can be of special interest because the larval stage is the longest in the life cycle of *Culicoides* and larval control measures can therefore be an efficient protection against adults (Kettle & Lawson 1952). In addition to the information about immatures, emergence traps can also reveal the seasonal abundance of *Culicoides* because it is possible to directly associate specific habitats with the present *Culicoides* species (Root & Gerhardt 1990).

In the last years, many studies about *Culicoides* used emergence traps (Dyce & Marshall 1989; Bishop *et al.* 1996a, 2005; Uslu & Dik 2007; Kirkeby *et al.* 2009; Foxi & Delrio 2010; Persson Vinnersten *et al.* 2010; González *et al.* 2013; Thompson, Jess & Murchie 2013; Harrup *et al.* 2013, 2014). However, almost all of these studies did not pay attention to the characteristics of the used traps that varied in material, shape or color. Moreover, environmental parameters were often measured only marginally. At the moment no study exists that sums up or compares the available trap types. As a result the catch of different types can hardly be compared without prejudice. In fact it is unknown if there is a significant effect of the different eclector types on the emergence of *Culicoides*.

This thesis was a methodical experiment to compare four eclector types that differed in color (black/white) and shape (box/funnel). The main objective was to investigate if the different types also differ in catch success. In addition, environmental parameters were measured inside and outside of the eclectors to record what breeding conditions were provided by the eclectors.

The two known vector species *C. chiopterus* (Meigen 1830) and *C. dewulfi* (Goetghebuer 1936) were chosen as subjects because their breeding is restricted to dung (Kettle & Lawson 1952; Kettle 1962; Conraths, F., Eschbaumer, M., Freuling, C., Gethmann, J., Hoffmann, B., Kramer, M., Probst, C., Staubach, C., Beer 2012). Dung – in this thesis used in the form of cow pats – is easily localizable and offers a restricted breeding environment that could be used to establish an experimental system as it is already implemented with the Australian vector *C. brevitarsis* Kieffer (Harrup *et al.* 2014).

## 2 Material and Methods

### 2.1 Collection of cow pat samples

The cow pats used as substrate in the experiment were collected on a farm near Ofen, a small city in the northwest of Germany (**Fig. 1**).



**Fig. 1:** Aerial image of the farm where the samples were taken from different meadows (white labels). Coordinates: meadow 1 = 53°09'53.9"N 8°09'04.8"E, meadow 2 = 53°09'58.4"N 8°09'05.5"E, meadow 3 = 53°09'59.6"N 8°08'46.4"E. (picture modified after Bing maps, Microsoft Corporation, 2014)

On June 10, 2014 a total of 25 cow pats of an age of about one and a half week were labeled in the field. All of them had a minimum size of about 20 cm<sup>2</sup> so that it was possible to take small samples of the margin of every cow pat without damaging a central part. These samples, collected with a tablespoon, were tested in the lab for colonization of *Culicoides* larvae with the Berlese device used and described by Steinke, Lühken & Kiel (2014).

On June 12 the cow pats tested positive for colonization were reviewed in the field. Eleven of them (five from meadow 1, four from meadow 2 and two from meadow 3) were chosen for the experiment. They were cut out carefully by using a common spade.

Excessive earth was removed by hand before the cow pats were stacked in open plastic boxes separated by plastic foil.

## 2.2 The different traps

Four different types of eclectors were used for the experiment, two box-traps and two funnel-traps (Fig. 2 A to D; based on traps from Lühken, Kiel & Steinke 2014a; Lühken *et al.* 2014b). The types with the same shape shared the same structure, only their color was different. This difference was reached by masking the half of the original milky white eclectors with black plastic foil. The letters A to D (A and B for the white eclectors as well as C and D for the black eclectors) were used as a code designation and will also be used in this thesis (Tab. 1)

**Tab. 1:** Overview of the characteristic of the four eclector types.

| Type | Color | Shape  | Volume (l) | Surface (cm <sup>2</sup> ) | Base (cm <sup>2</sup> ) |
|------|-------|--------|------------|----------------------------|-------------------------|
| A    | White | Box    | 5,9        | 1400                       | 306                     |
| B    | White | Funnel | 11         | 1770                       | 962                     |
| C    | Black | Box    | 5,9        | 1400                       | 306                     |
| D    | Black | Funnel | 11         | 1770                       | 962                     |

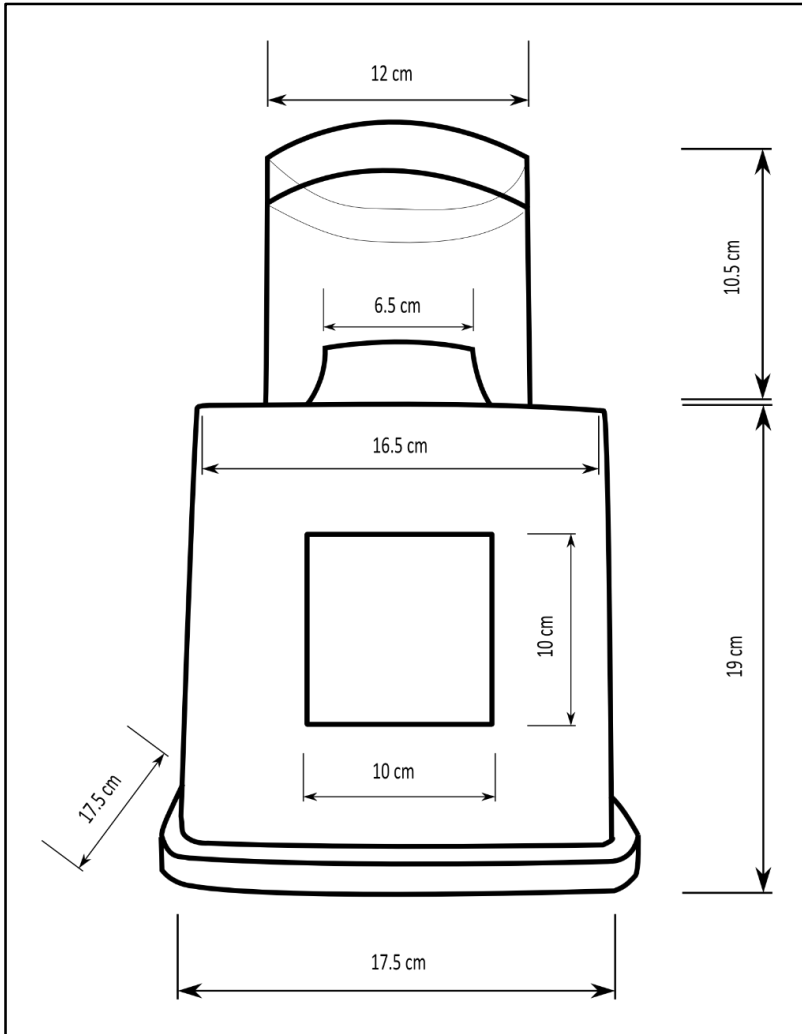
The main component of the box-eclectors (Fig. 3) was a reversed white plastic bucket that had a nearly squared form and was narrowed to the top. Two openings at opposing sides of the eclector were covered with fine gaze (aperture size = 100  $\mu\text{m}$ ) and served as aeration windows. A hole in the top area connected the box with a transparent plastic tin that served as collection container. Inside the tin a ridge of  $2.5 \pm 1$  cm surrounded the opening, forming a gutter between it and the side wall of the tin. This gutter served as the catchment basin of the eclector. The lid of the tin was removable to make it possible to empty the trap and humidify the samples. The lid of the bucket was used to caulk the eclector to ensure that no insects could escape or invade from below. It also prevented diffusion. The whole eclector was slightly translucent in its white form. The black plastic foil was nontransparent.



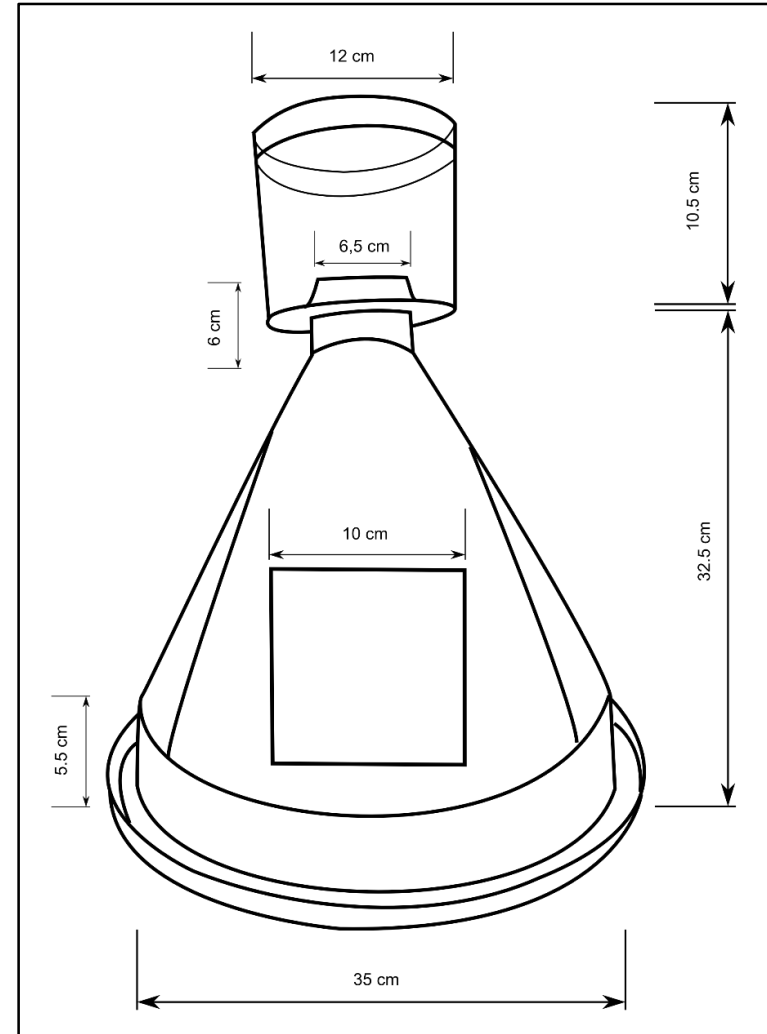


**Fig. 2:** The different traps used in this experiments. A, C: box-like electors, B, D: funnel-electors. The traps with the same shape shared the same structure. The different colors were applied by covering originally white electors with black plastic foil. The white lateral squares are mesh-covered aeration windows, the transparent plastic tin served as collection container. The letters A to D were used as a code designation.

The main component of the funnel-electors (Fig. 4) was a reversed funnel usually used in industry. They also had two opposing aeration windows with the same size and gaze as the box-electors. Moreover, they used the same plastic tin as collection container. A difference to the box-electors was that the funnel-electors had no lid by default so it was necessary to place them on white plastic canvas and attach them with tape to ensure caulking. The funnel-electors were made up of the same white plastic as the box-electors with a similar thickness and were therefore similar translucent.



**Fig. 3:** Schematic drawing of the box-electors. These traps were based on a reversed plastic bucket and had a volume of 5.9 l as well as a surface of 1400 cm<sup>2</sup> (without lateral aeration windows and tin).



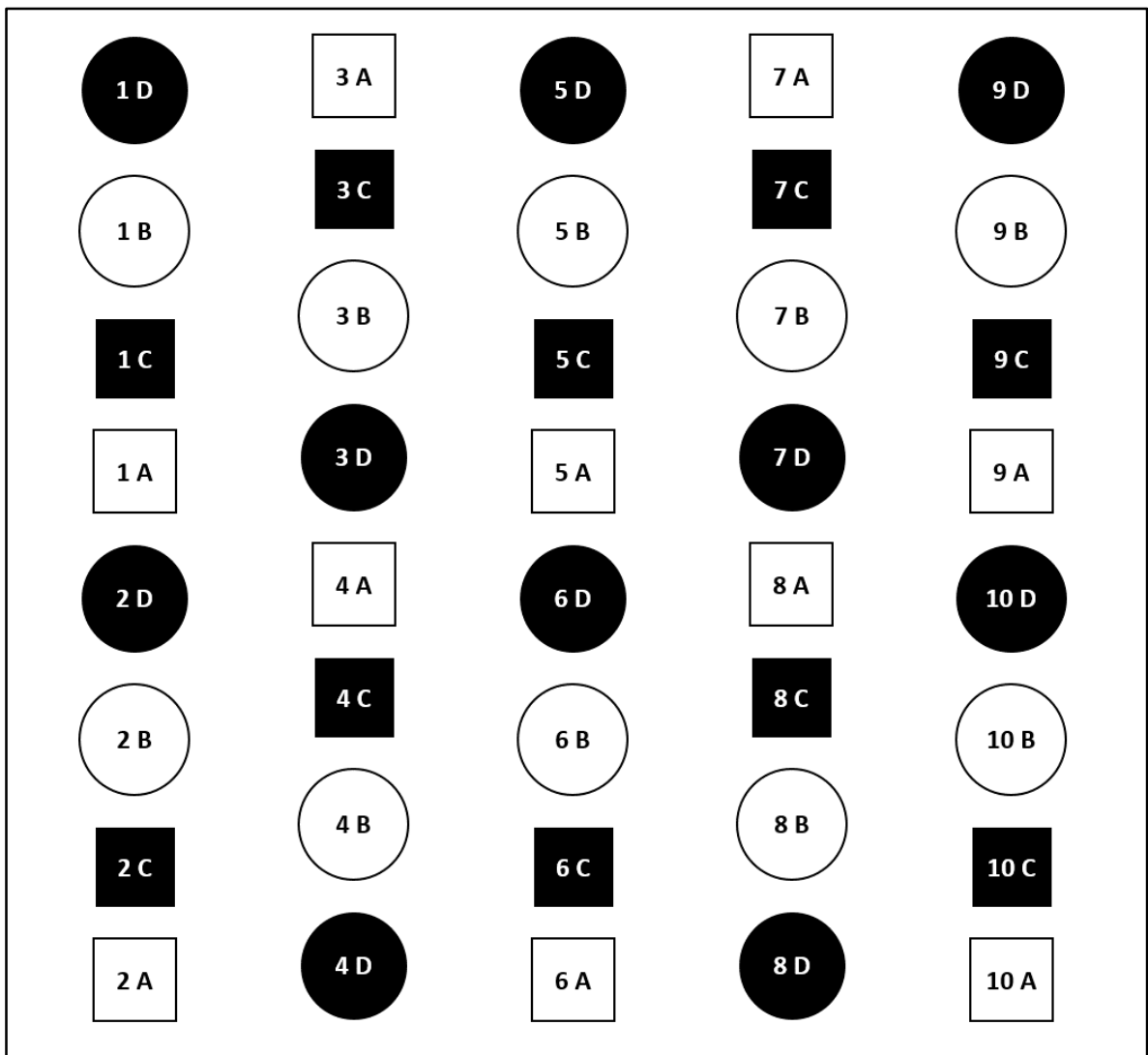
**Fig. 4:** Schematic drawing of the funnel-electors. These traps were based on a funnel usually used in industry. They had volume of 11 l as well as a surface of 1770 cm<sup>2</sup> (without lateral aeration windows and tin).

### 2.3 Setup of the experiment

The setup of the traps took place on June 12, 2014 right after the collection of the cow pat samples in the field. The testing site was located in the botanical garden of the University of Oldenburg (53°09'05.4"N 8°09'45.1"E). In detail it was a lawn that was sheltered from wind by a building in the north and a greenhouse on a high cement fundament respectively vegetation on the other sides. There was no source of shadow except a small tree with nearly no vegetation nearby. The effect of the tree was estimated to be minimal and was therefore ignored in the experiment.

Each cow pat was divided into four equal subsamples of 7x7 cm using a knife. Afterwards the subsamples were distributed to a group of four emergence traps (1x A, 1x B, 1x C and 1x D). In the end, ten of these groups existed. After the lawn was cut on an area of about 5 x 6 m the eclectors were arranged according to (Fig. 5). The groups were arranged in clusters with the consisted order D -> B -> C -> A. Nevertheless, this order was reversed in every second row to avoid anomalies possibly caused by a consistent alignment of the whole setup. The distance between the traps was about 25-35 cm, the distance between the rows was about 45-55 cm.

After placing the traps they were fixed to the ground with tent pegs to avoid a shifting of the traps caused by wind or accidentally physical contact. The samples were humidified with 20 ml of town water by using a spray diffuser. The gutters inside the collection containers were completely filled up with salt solution (200 g NaCl / L H<sub>2</sub>O). Finally, some drops of dish liquid were added to the solution to lower its surface tension.



**Fig. 5:** Alignment of the electors. The letters represent the type of elector (A = white box, B = white funnel, C = black box, D = black funnel). The numbers represent the different groups. Each group contained samples from a single cowpat to enable a comparison of the different types.

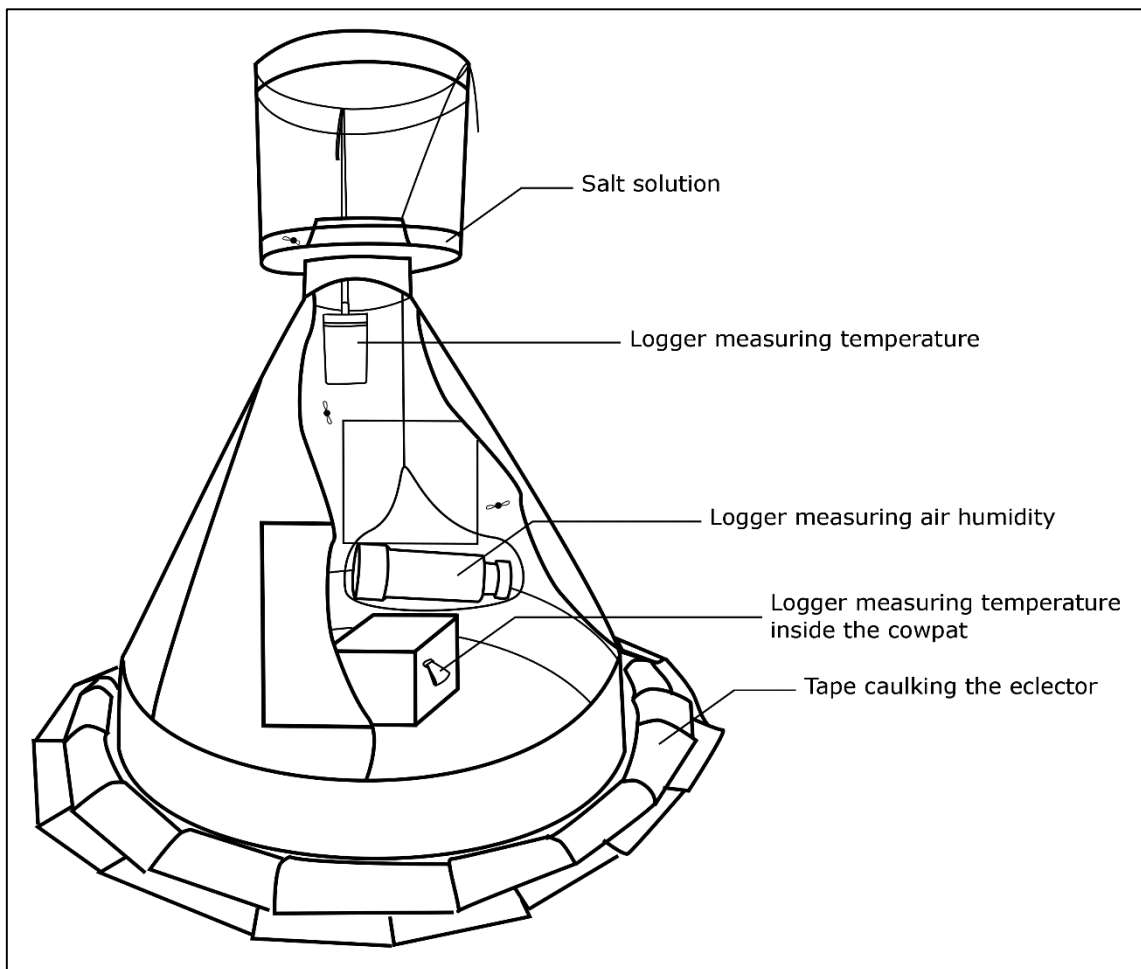
## 2.4 Measurement of the environmental parameters

Three groups of electors, a total of 12, were additionally equipped with loggers to measure temperature and relative humidity during the experiment. Every elector in the groups got an equal set of three loggers (Fig. 6). The first logger (iButton DS1921G, Maxim Integrated, San Jose, CA, USA) was covered with a rubber casing to protect it from humidity and pushed into the cow pat-sample before it was placed on the base of the elector. It measured the inner temperature of the sample. The second logger (Hobo® Pendant, Onset Computer Corp., Cape Cod, Mass., USA) measured the general temperature inside the elector. This logger was placed by attaching the logger's string with tape to the inner surface of the elector so it hang next to the opening in the top area (Fig. 6). The third logger (HOBO® Pro v2, Onset Computer Corp., Cape Cod, Mass.,

USA), used to measure temperature and relative humidity inside the eclector, was placed in a small net with a long string. This net was initially taped to the inner surface of the eclectors between both aeration windows with the sensing element 4 cm (box-eclectors) to 5.5 cm (funnel-eclectors) above the ground. But because of the high humidity inside the eclectors and the high weight of the logger the tape was not able to keep the logger in a fixed, safe position. Therefore another way of positioning had to be used in the second half of the experiment, beginning with June 11, 2014. The net was hanged into the eclector by sticking its string between the plastic cylinder and its lid (Fig. 6). The net was positioned in a way that the sensing element points to the inner surface between the two openings and had approximately the same height as before. Because the high intersection of the funnel-eclectors and the cow pat sample which made it sometimes impossible to lower the net deep enough, the same position for the sensing element was not always possible. So a deviation of maximal 3.5 cm (box-eclectors) and 8 cm (funnel-eclectors) had to be taken into account. All loggers recorded the climate data once every hour.

On July 7, the grass between the eclectors was cut again to minimize the effect of surrounding vegetation to the traps. On August 7, one and a half week after the end of the experiment, all loggers were removed from the eclectors to readout the recorded climate data. Afterward the light intensity inside every eclector was measured with a luxmeter (PeakTech® 5025, PeakTech Prüf- und Messtechnik GmbH, Ahrensburg, Germany) that was placed at the bottom of the eclectors at the same position that the cow pat samples had.

Additional general weather data was obtained from the technical property management of the University of Oldenburg (<http://www.uni-oldenburg.de/wetter/>). The wind data was measured on the building north of the testing site, all other weather data provided was measured approximately 1.2 km away from the testing site on a central building of the campus Haarentor. Although this proximity increases the data value it has to be mentioned that the sensing elements of the university were replaced in September 2014 due to their old age.



**Fig. 6:** Inner view of a funnel-elector. The sample, here represented by a cube, was located on the plastic canvas right below the top opening. The elector was attached to the canvas and therefore caulked. Three different loggers measured Temperature and relative humidity at different points.

## 2.5 Sampling of Culicoides

The traps were controlled three times every week on Monday, Wednesday and Friday at 10:00 beginning on June 13. Every cow pat was humidified with 20 ml of town water by using a spray diffuser. In case there was salt on the cow pats because salt crystals had formed at the opening and had fallen down, the salt was carefully removed with a stick before humidifying. Both the lids of the plastic cylinders and the cylinders themselves were controlled for any kind of insects. Insects caught in the gutters were collected with an Eppendorf-pipette. Insects adhered to the lid or the side walls were humidified or washed up with salt water to enable the collection with the pipette. All insects were stored in 76 % ethanol in small plastic bottles. Bigger individuals were collected by using tweezers. If necessary, salt crystals caused by evaporation were removed from the gutters using a spoon. The salt solution was refilled if necessary.

In the lab the bottles were emptied into petri dishes and their content examined under a stereo microscope. Individuals belonging to the *Culicoides* genus were identified using the identification key of Campbell & Pelham-Clinton (1960). They were stored in 76 % ethanol in Eppendorf tubes. The bycatch was discarded.

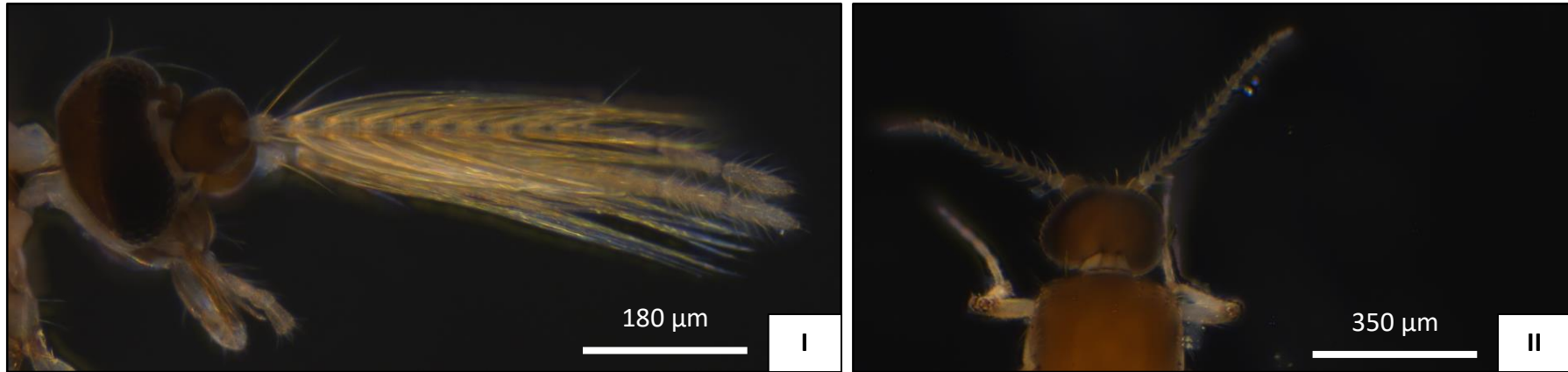
The experiment was stopped after 54 days on July 28. The last emergence occurred on July 14.

## **2.6 Determination of the found individuals**

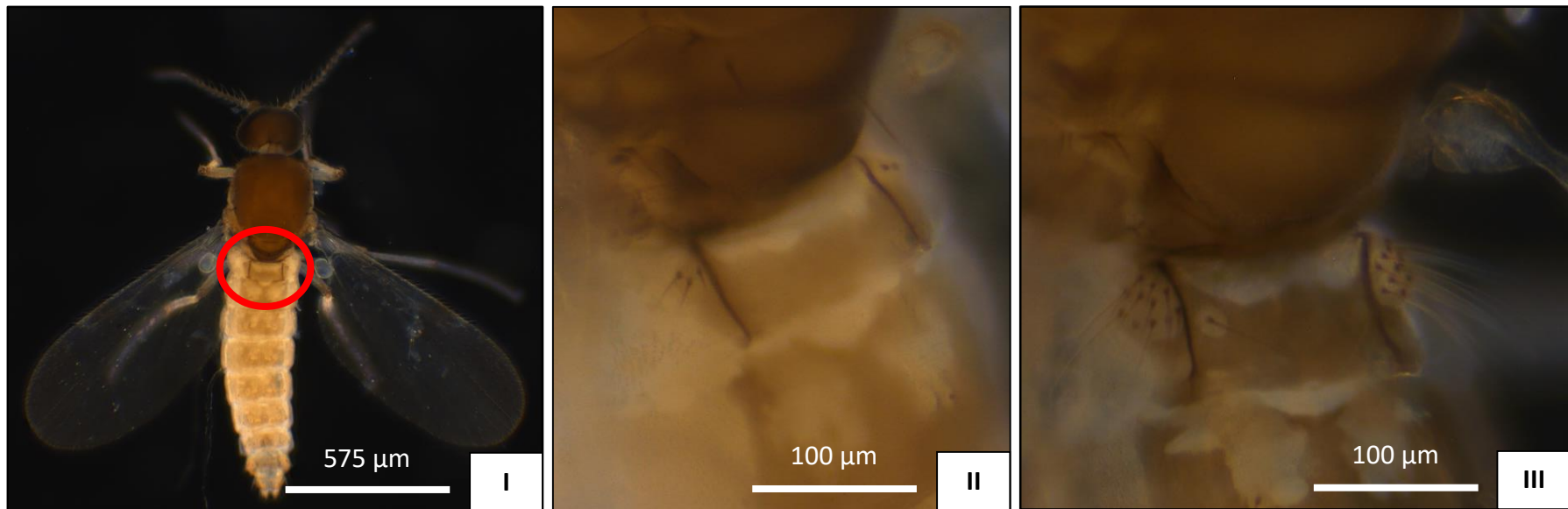
The determination of the found individuals was based exclusively on their morphology according to Campbell & Pelham-Clinton 1960. The decisive character to separate males and females was the shape of the antennae (**Fig. 7**). The number of hairs on the first abdominal tergite allowed the separation of the females (**Fig. 8**), the males could be identified by the shape of their genitalia (Fig. 9, Fig. 10).

## **2.7 Statistical analysis**

SPSS in version 22 (IBM Inc., Armonk, USA) was used for all statistical analysis. The analysis of the climate data was done separately for day (6:00 to 22:00) and night (23:00 to 05:00) to avoid false conclusions drawn by only using mean values. These periods were chosen because of the times of sunrise and sunset during the experiment. They ranged from 5:00 ± 4 minutes a.m. to 21:30 ± 4 minutes p.m. (depending on private data provider used, there was no official non-commercial source for that kind data in this region).

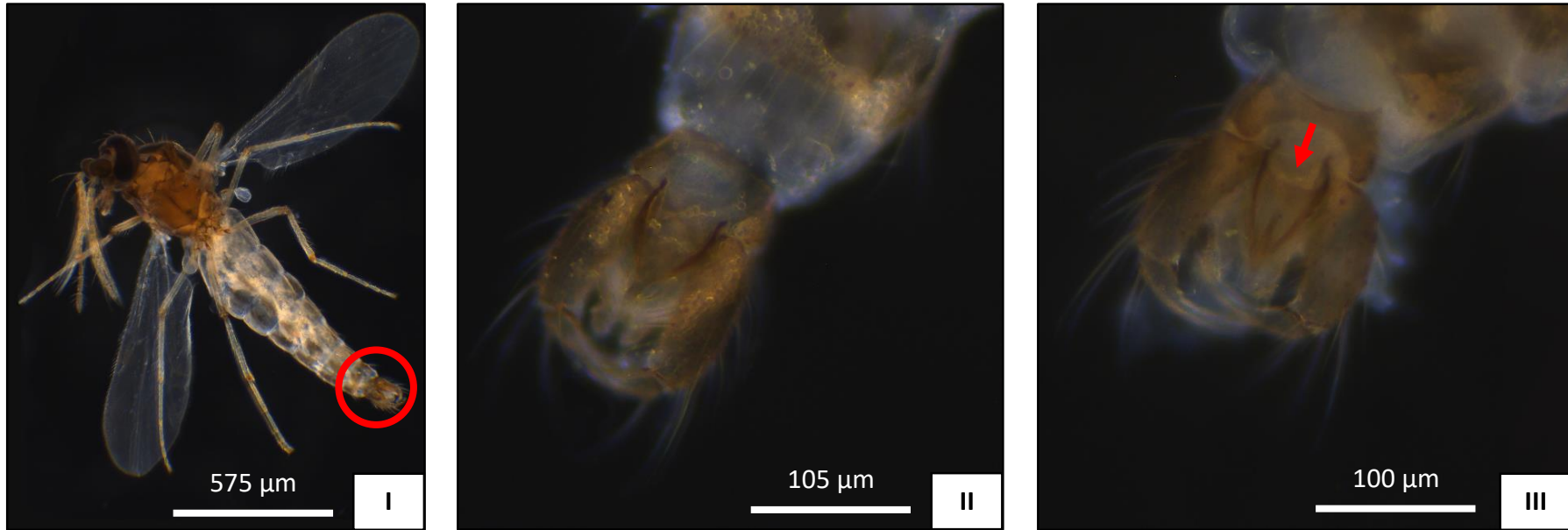


**Fig. 7:** Sexual dimorphism in *Culicoides*. I: the antennae of male *Culicoides* are fanned what enables an easy identification under a stereomicroscope. II: the female antenna as a reference.

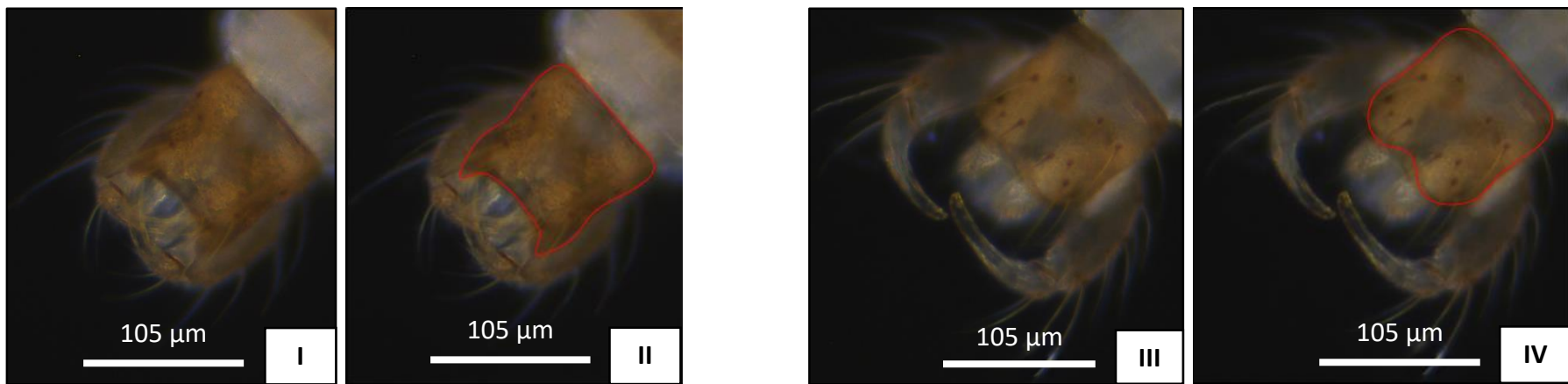


**Fig. 8:** Determination of the females. The number of hairs on the first abdominal tergite made it possible to separate both species. I: dorsal view on a female *Culicoides* sp. with red circle marking the tergite. II: *C. chiopterus* with 1-8 hairs. III: *C. dewulfi* with >8 hairs.





**Fig. 9:** Determination of the males. The main character that was used for the determination was the shape of the genitalia. I: ventral view on a male *Culicoides* sp. with a red cycle marking the position of the genitalia. II: ventral view on the genitalia of *C. chiopterus*. III: ventral view on the genitalia of *C. dewulfi* with the red arrow marking a basal transverse bar on the aedeagus which is typical for *C. dewulfi*.



**Fig. 10:** Dorsal view on the male genitalia. I, II: the shape of the hypopygium of *C. chiopterus* had two typical 'horns'. III, IV: the shape of the hypopygium of *C. dewulfi* was rounded.

### 3 Results

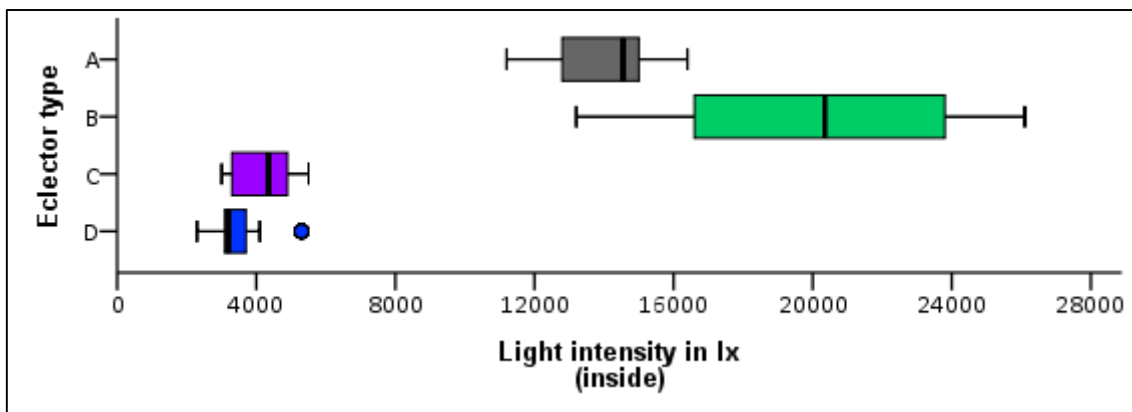
#### 3.1 Light intensity outside the eclectors and length of day

During night the light intensity was too low to be measured on 23 of the 46 days of the experiment. The maximal light intensity during the other nights was 611 lx (Tab. 2). During the day the light intensity had no conspicuities with a mean of 38143 lx and maxima up to the cap of 100,000 lx. There were some cloudy days between June 16 and 21 and on June 8 that resulted in a lower overall and maximal light intensity.

On the first day of the experiment the length of day was 16:54 hours. It increased continuously to 16:58 hours on June 21 which was the longest day of 2014. The following decrease reduced the length of day down to 15:50 hours on the last day of the experiment.

#### 3.2 Light intensity inside the eclectors

The light intensity inside the eclector types differed significantly (One-way ANOVA,  $p < 0.000$ ). The measured values were far higher inside the white types A and B than in the black types C and D (Fig. 11). Simultaneously, the white types exhibited a wider variance. Eclector 2D was an anomaly with a value of 5300 lx compared to the mean value of the other type D eclectors that was 3222 lx. Because the light intensity inside the eclectors was measured only once it was not possible to ensure that this anomaly was caused by the eclector and not by mistakes made during the measurement.



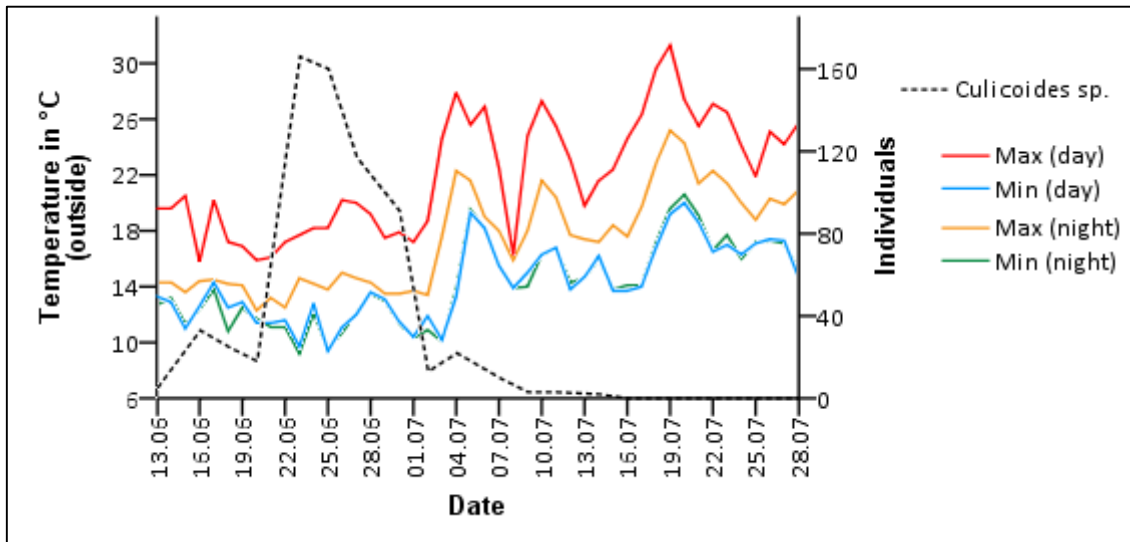
**Fig. 11:** Light intensity inside the eclectors. Eclector types: A= white box, B = white funnel, C = black box, D = black funnel. The outlier 2D had a value of 5300 lx while the other type D eclectors had a mean value of 3222 lx.

**Tab. 2:** Summary of the climate data measured during the experiment. Temperature and relative humidity were measured both inside and outside the eclectors, all other data was only measured outside. The “Difference”-rows represent the differences between all eclectors of one measuring point. Eclector types: A= white box, B = white funnel, C = black box, D = black funnel.

|   | Type       | Day    |        |        |        | Night  |        |        |        |
|---|------------|--------|--------|--------|--------|--------|--------|--------|--------|
|   |            | Min.   | Max.   | Mean   | Median | Min.   | Max.   | Mean   | Median |
| Temperature inside cow pat samples (°C)         | A          | 8.8    | 45.6   | 23.2   | 22.1   | 8.1    | 24.0   | 15.5   | 15,2   |
|   | B          | 9.2    | 52.7   | 24.6   | 23.2   | 8.3    | 24.5   | 15.7   | 15,4   |
|   | C          | 8.8    | 47.3   | 22.9   | 21.7   | 8.0    | 24.4   | 15.6   | 15,4   |
|   | D          | 9.1    | 42.9   | 23.1   | 22.2   | 8.5    | 23.8   | 15.7   | 15,5   |
|   | Difference | 0.2    | 19.9   | 4.2    | 2.8    | 0.3    | 2.7    | 1.1    | 1.1    |
| Temperature at top of the eclectors (°C)        | A          | 7.5    | 55.3   | 25.9   | 23.2   | 6.4    | 23.2   | 14.2   | 14,1   |
|   | B          | 7.8    | 63.4   | 27.0   | 23.9   | 6.5    | 22.8   | 14.3   | 14,1   |
|   | C          | 7.4    | 59.6   | 26.4   | 23.5   | 6.2    | 22.8   | 14.4   | 14,2   |
|   | D          | 8.1    | 59.5   | 26.6   | 23.9   | 6.6    | 22.8   | 14.4   | 14,4   |
|   | Difference | 0.3    | 26.9   | 5.3    | 2.9    | 0.4    | 2.2    | 1.1    | 1.1    |
| Temperature at the side of the eclectors (°C)   | A          | 7.5    | 51.8   | 24.5   | 22.2   | 6.3    | 24.5   | 15.9   | 16,3   |
|   | B          | 7.1    | 59.3   | 26.0   | 22.5   | 5.8    | 24.9   | 15.8   | 16,3   |
|   | C          | 7.3    | 52.9   | 24.8   | 22.3   | 6.3    | 24.4   | 16.0   | 16,3   |
|   | D          | 7.2    | 57.1   | 25.6   | 22.6   | 5.9    | 23.7   | 16.0   | 16,6   |
|   | Difference | 0.1    | 25.4   | 4.4    | 2.3    | 0.2    | 10.6   | 1.6    | 0.9    |
| Difference between all temperature measurements |            | 0.7    | 33.3   | 9.0    | 6.3    | 1.1    | 15.2   | 4.2    | 2,9    |
| Temperature outside the eclectors (°C)          |            | 9.4    | 31.3   | 18.7   | 18.1   | 9.2    | 25.2   | 15.3   | 14.6   |
| Relative humidity inside the eclectors (%)      | A          | 19.9   | 99.7   | 69.4   | 69.7   | 43.2   | 99.2   | 84.3   | 90,4   |
|   | B          | 9.4    | 100.0  | 65.4   | 65.1   | 44.2   | 100.0  | 84.0   | 89,9   |
|   | C          | 24.7   | 100.0  | 68.9   | 68.7   | 46.0   | 99.4   | 83.6   | 89,4   |
|   | D          | 20.9   | 100.0  | 69.1   | 68.0   | 44.9   | 100.0  | 85.9   | 92,4   |
|   | Difference | 2.5    | 57.4   | 17.0   | 14.6   | 2.1    | 44.4   | 11.5   | 10,0   |
| Relative humidity outside the eclectors (%)     |            | 24.3   | 96.0   | 60.7   | 59.8   | 49.7   | 96.2   | 79.0   | 81.1   |
| Air pressure (hPa)                              |            | 1003.0 | 1038.0 | 1020.8 | 1021.0 | 1004.0 | 1036.0 | 1020.6 | 1019.0 |
| Light intensity (lx)                            |            | 0      | 100000 | 38143  | 29866  | 0      | 611    | 10     | 0      |
| Rainfall (mm)                                   |            | 0.0    | 19.5   | 1.0    | 0.0    | 0.0    | 19.6   | 0.4    | 0.0    |
| Wind speed (mm)                                 |            | 0.2    | 4.5    | 1.8    | 1.7    | 0.2    | 3.1    | 0.8    | 0.7    |

### 3.3 Temperature outside the eclectors

The temperature outside the eclectors ranged from 9.2 °C to 25.2 °C during the night and from 9.4 °C to 31.3 °C during the day (Tab. 2). The main emergence took place during a period of relatively stable and moderate temperatures (Fig. 12). After July 1, when the temperature began to rise to a higher overall range, only sporadic emergence occurred.



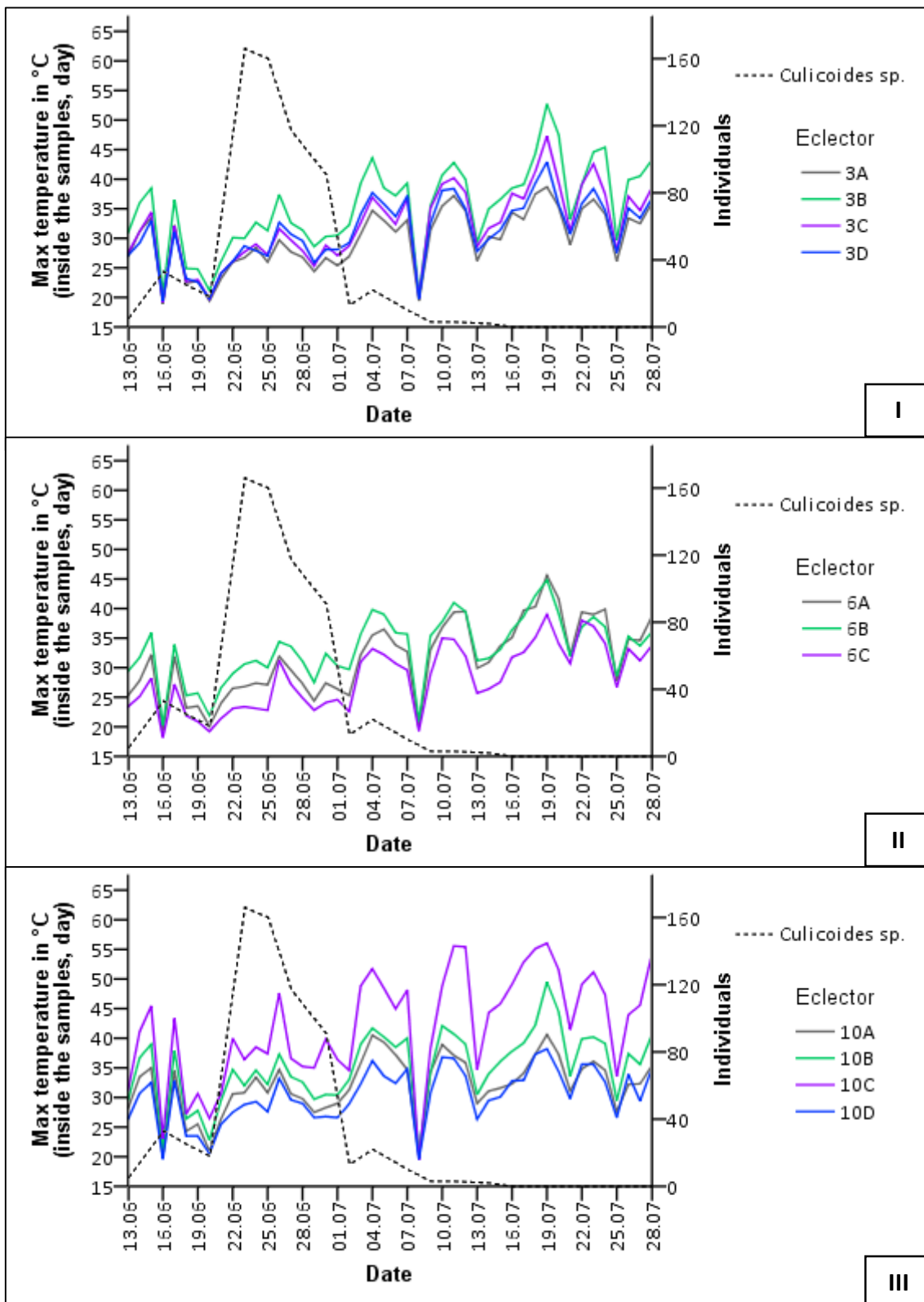
**Fig. 12:** Temperature outside the eclectors. The underlying data was recorded approximately 1.2 km away from the testing site by the technical property management of the University of Oldenburg. The dotted line represents the total catch of *Culicoides sp.* as a reference.

### 3.4 Temperature inside the cow pat samples

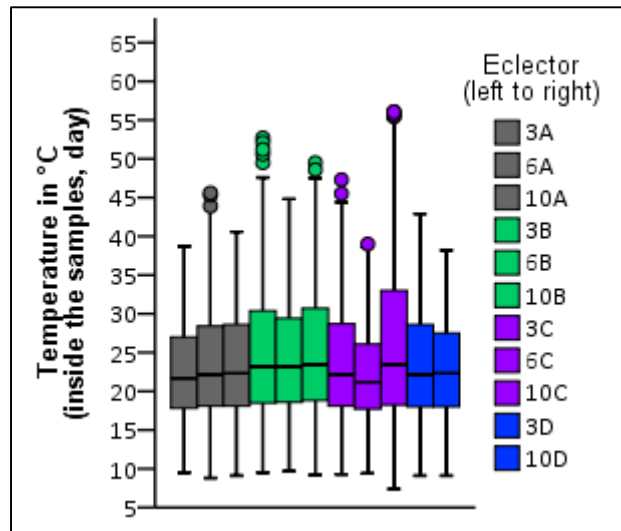
The temperature inside the samples ranged from 8.0 °C to 24.5 °C (Tab. 2) during the night. All eclectors shared a very similar temperature development with a maximal temperature difference of 2.7 °C between the eclectors. The curve progression was comparable to the temperature development outside (Fig. 12)

During the day, the temperature ranged from 8.8 °C to 52.7 °C with a maximal temperature difference of 19.9 °C (Tab.2). While the minimal temperatures generally accords to the nightly values there were two conspicuities for the maximal temperatures during the day. Firstly, the small emergence peak on June 20 (that contained mostly catch from group 6) went along with a temperature drop (**Fig. 13**). After that day the temperature raised again until a second drop on June 20 occurred – together with the start of the main emergence. Secondly, the eclector 10C showed much higher maximal temperatures than the other eclectors (**Fig. 13**, Fig. 14). Simultaneously it was possible

to notice higher maximal temperatures for the type B electors as well as a shorter range and lower values of the type D electors and elector 6C (Fig. 14).



**Fig. 13:** Development of the maximal temperatures inside the samples. I: group 3, II: group 6, III: group 10. Elector types: A= white box, B = white funnel, C = black box, D = black funnel. Elector 6D is missing in figure II because the logger was damaged and could therefore not be read out. The dotted line represents the total catch of *Culicoides sp.* as a reference.



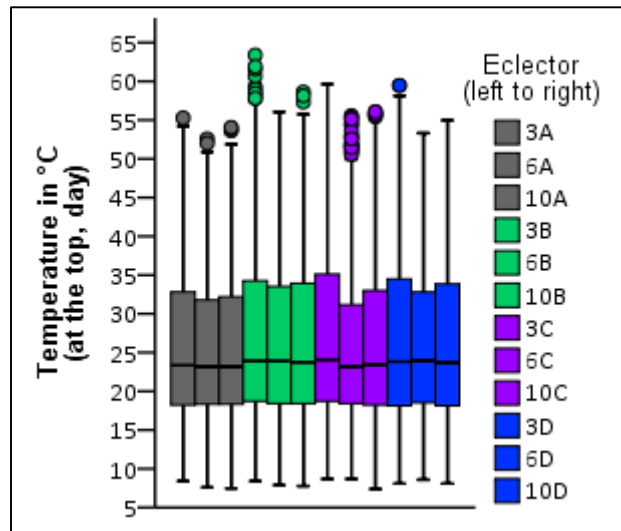
**Fig. 14:** Boxplot of the temperatures inside the cow pat samples during the day. The lines within the boxes represent the median values. Eclector types: A= white box, B = white funnel, C = black box, D = black funnel. Eclector 6D is missing in this figure because the logger was damaged and could therefore not be read out.

### 3.5 Temperature at the top of the eclectors

The nightly temperatures at the top of the eclectors ranged from 6.2 °C to 23.2 °C (Tab. 2). The temperature difference between the eclectors was low with a maximum of 2.2 °C. The development of the temperature had the same characteristics as the temperature outside (Fig. 12).

During the day, the temperature values were widely spread from 7.4 °C to 63.4 °C (Tab. 2). The eclectors 3A and 6C differed from the other ones by their partly lower maximal temperature. Nevertheless the extreme temperature differences up to 26.9 °C did not only occur within the maxima but during different times during the day. It was not possible to trace these differences back to single eclectors because the time of the differences as well as the composition of the eclectors that caused the differences varied. When comparing all eclectors in a boxplot it becomes apparent that the overall temperature inside group 3 was slightly higher than in group 6 or group 10 (**Fig. 15**).

The development of the maximal temperature at the top generally corresponds the development inside the samples (**Fig. 13**) however the curve was shifted towards higher temperatures and the peaks are more striking. The correlation between temperature drops and increasing emergence was also visible here.

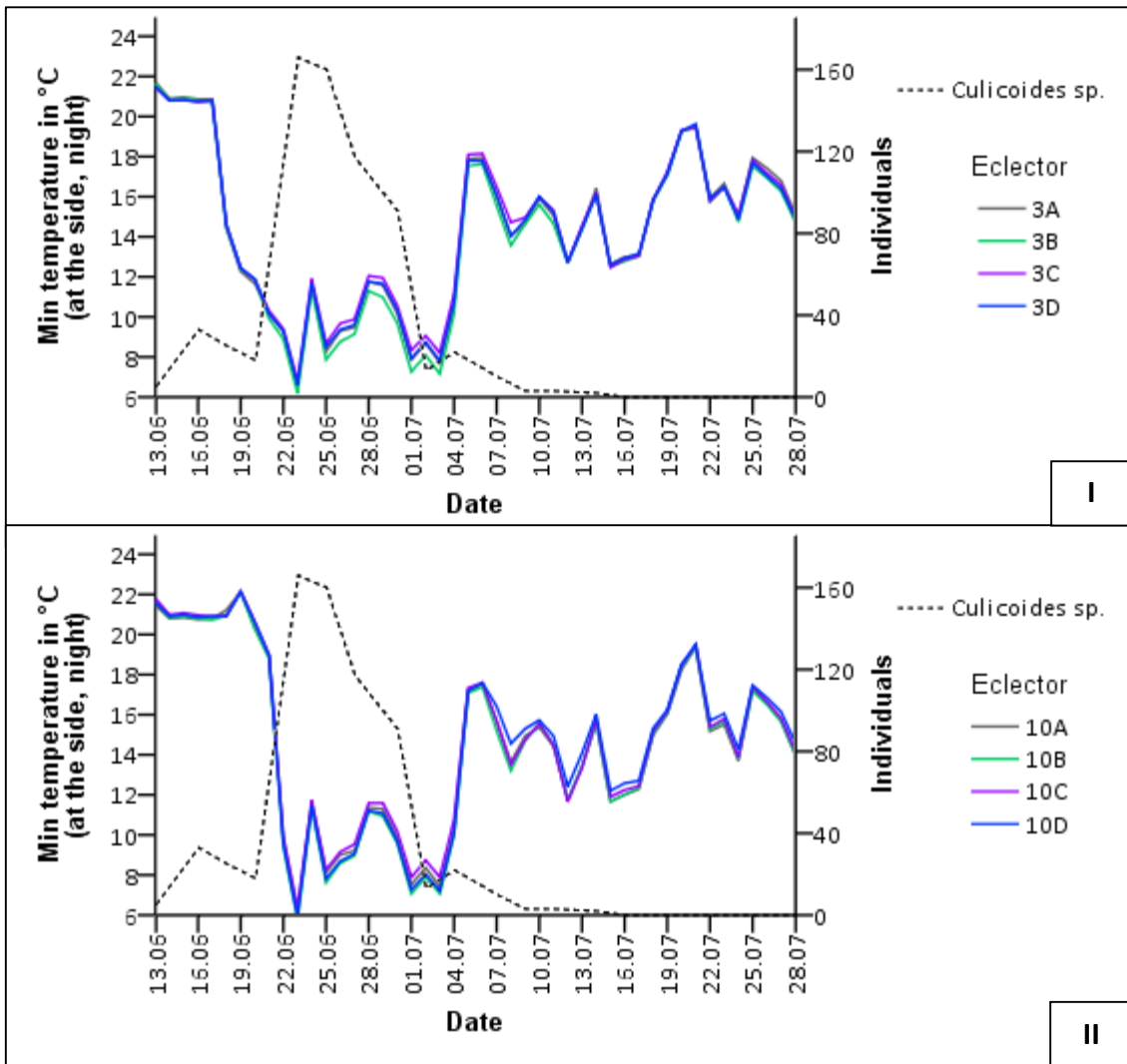


**Fig. 15:** Boxplot of the temperatures at the top during the day. The lines within the boxes represent the median values. Eclector types: A= white box, B = white funnel, C = black box, D = black funnel.

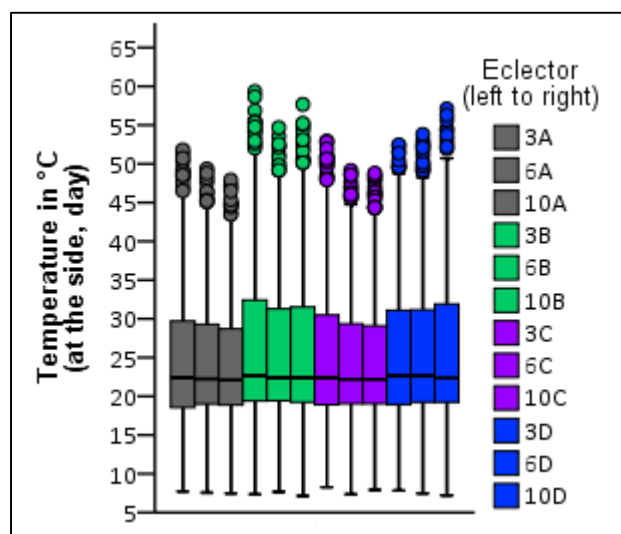
### 3.6 Temperature at the side

During the night, the temperature at the side ranged from 5.8 °C to 24.9 °C (Tab. 2). In contrast to the nightly temperatures of the other measuring points the temperature difference between the eclectors here reached 10.6 °C. The reason for this deviation was the unusual temperature development: after a stable period of five days with temperatures between 20.7 °C to 24.9 °C there was an extreme temperature drop towards a minimum of 5.8 °C on June 23 (**Fig. 16**). The drop occurred earlier within group 3 and therefore caused the high temperature difference during the night. The same delay applied to the maximal temperatures however they dropped slower and stopped at 11 °C. Apart from the development the temperature differences within the groups were as low as at the other measuring points with a maximum of 1.5 °C.

The temperature during the day ranged from 7.1 °C to 59.3 °C with a maximal difference of 25.4 °C between the eclectors (Tab. 2). The maximal temperature at the side was widely comparable to the temperature inside the samples (Fig. 13). It was also possible to remark the correlation between temperature and emergence. The eclector 3B reached higher temperatures than the other eclectors of group 3 while both types C and D were dominant within group 6 and group 10. All in all the temperatures at the side were the most diverse, a fact that is also mirrored by **Fig. 17** and **Fig. 18**. Here all eclectors exhibited several outliers while the eclectors 10B, 6D and 10D showed higher values when compared with the differentiation of the types A and C.

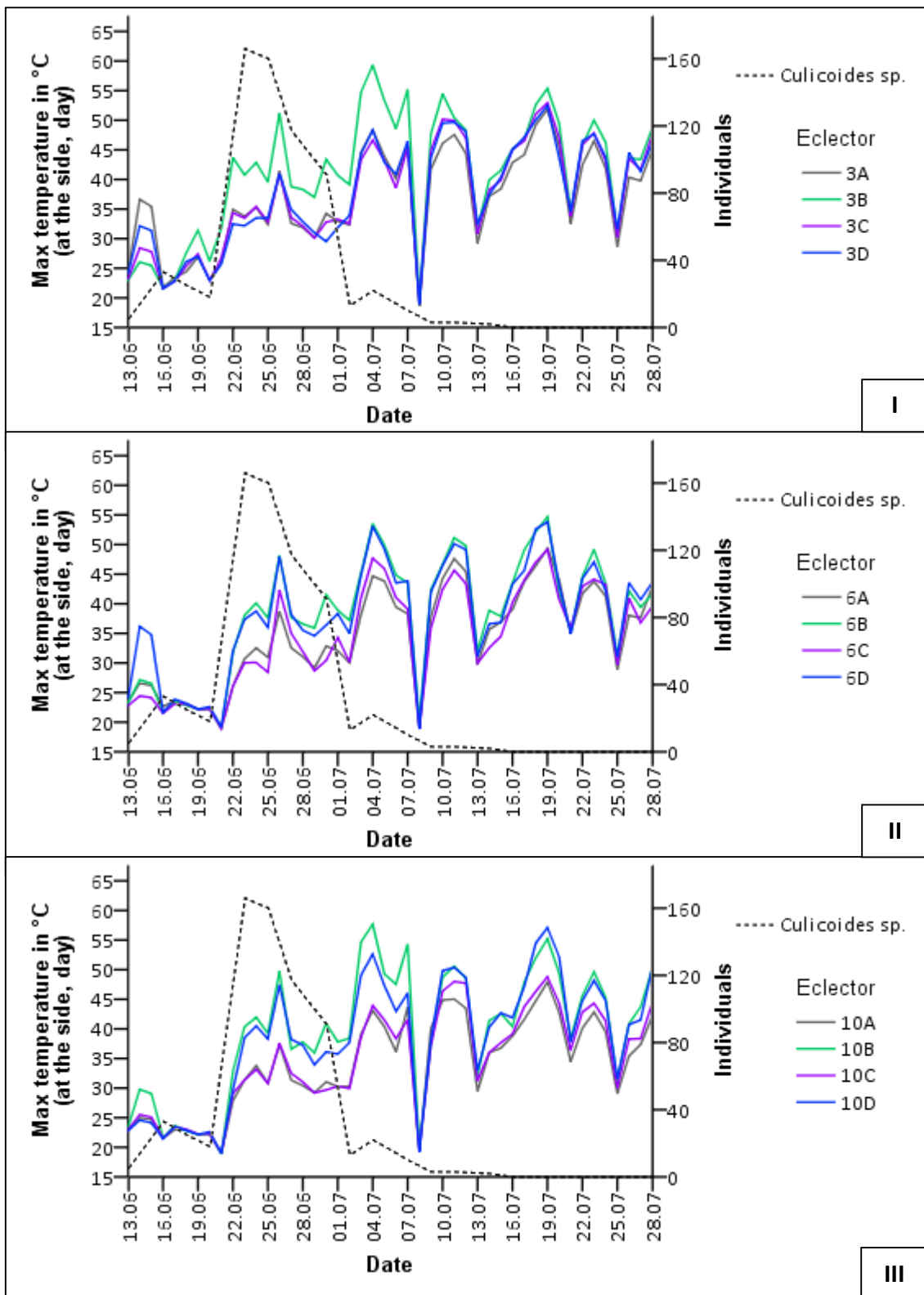


**Fig. 16:** Development of the minimal temperature during the night. I = group 3, II = group 10. Because the groups 6 and 10 had a very similar curve progression, II represents both groups in this figure. Eclector types: A= white box, B = white funnel, C = black box, D = black funnel. Dotted line = Emergence.



**Fig. 17:** Boxplot of the temperature at the side of the eclectors during the day. The lines within the boxes represent the median values. Eclector types: A= white box, B = white funnel, C = black box, D = black funnel.

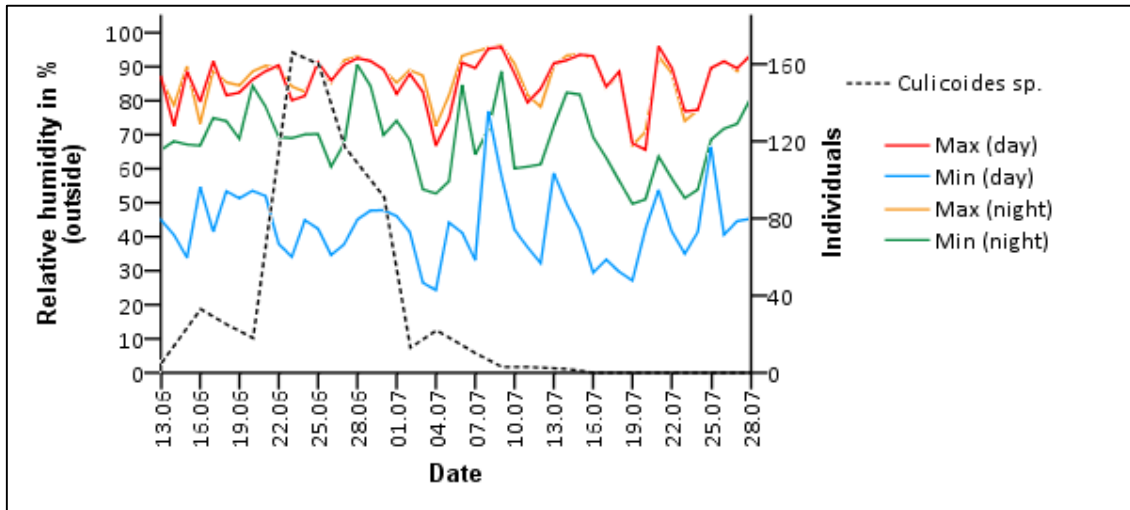




**Fig. 18:** Maximal temperature at the side of the eclectors during the day. I: group 3, II: group 6, III: group 10. Eclector types: A= white box, B = white funnel, C = black box, D = black funnel. The dotted line represents the total catch of *Culicoides sp.* as a reference.

### 3.7 Relative humidity outside the eclectors and rainfall

The relative humidity outside the eclectors ranged between 24.3 % and 96.0 % during day and between 49.7 and 96.2 % during night (Tab. 2). Although there was a remarkable, slow fluctuation none of the small peaks could be pulled together with other aspects of the experiment (**Fig. 19**). The rainfall that was loosely coherent with the relative humidity also had no conspicuousness.



**Fig. 19:** Development of the relative humidity outside the eclectors during the experiment. The dotted line represents the total catch of *Culicoides sp.* as a reference.

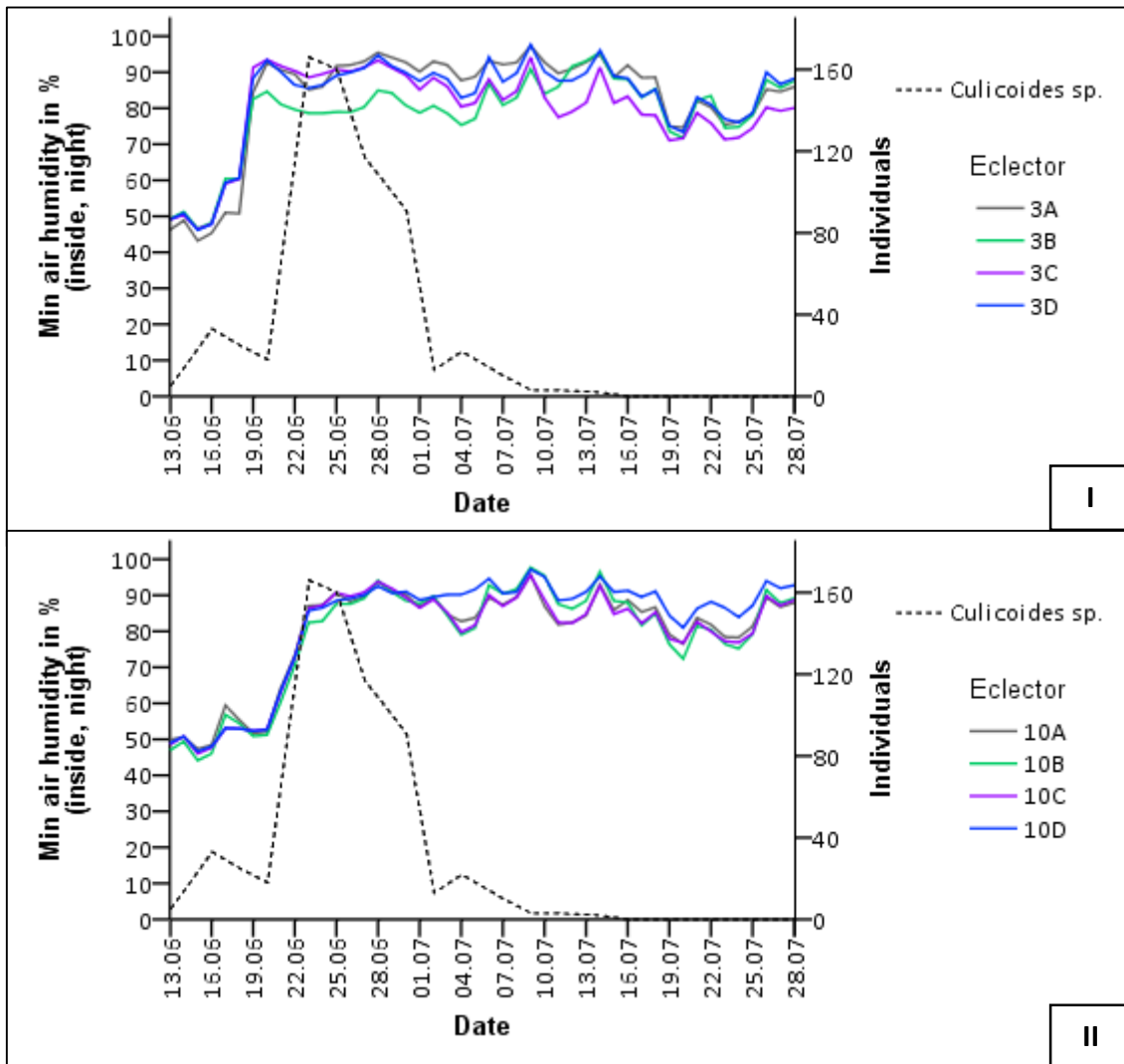
### 3.8 Relative humidity inside the eclectors

The relative humidity inside the eclectors ranged from 9.4 % to 100 % during day and from 44.2 % to 100 % during night (Tab. 2). Contrary to the development of the temperature at the side of the eclectors (**Fig. 16**) the relative humidity during night began to raise two days after the beginning of the experiment (**Fig. 20**). Identical was the earlier change of the environmental factor within group 3. Nevertheless, all groups reached a stationary phase until June 23. After that day there were increasing but small fluctuations without outstanding peaks.

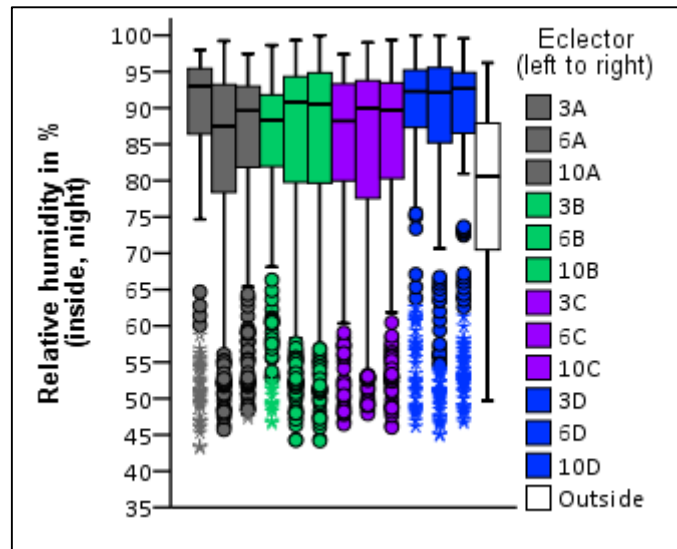
The value distribution of the relative humidity during the night accorded this observation, showing a wide overall range for all eclectors along with a comparatively small interquartile range (**Fig. 21**). What caught the attention is that the type D eclectors had a higher relative humidity than the other types.

The development of the maximal relative humidity during the day was comparable to the development of the relative humidity at night regarding to the curves and values.

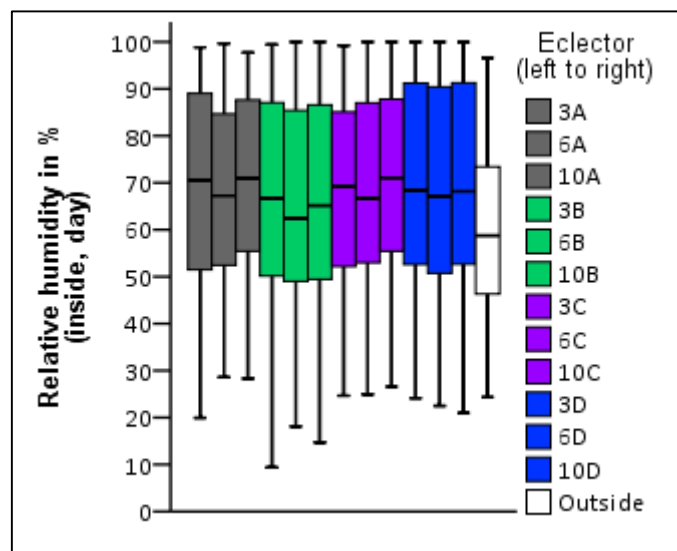
The only exception was a small peak that occurred on June 18 within group 6 and 10. Nevertheless the variance of the values was lower here and no outliers occurred (Fig. 22).



**Fig. 20:** Development of the minimal relative humidity at night. I: group 3, II: group 6, III: group 10. A= white box, B = white funnel, C = black box, D = black funnel. The relative humidity of group 3 changed earlier than the one of group 6 or 10. The dotted line represents the total catch of *Culicoides sp.* as a reference.



**Fig. 21:** Value distribution of the relative humidity during the night. The lines within the boxes represent the median values. A= white box, B = white funnel, C = black box, D = black funnel.



**Fig. 22:** Value distribution of the relative humidity during the day. The lines within the boxes represent the median values. A= white box, B = white funnel, C = black box, D = black funnel.

### 3.9 Atmospheric pressure

Because the city of Oldenburg lies only about five meters above sea level, the atmospheric pressure was expected to be about standard 1,013 hPa. In fact, the measured mean was 1,021 hPa (Tab. 2). When leaving out the general fluctuation it is possible to remark an overall trend towards a lower atmospheric pressure towards the end of the experiment (**Fig. 23**).

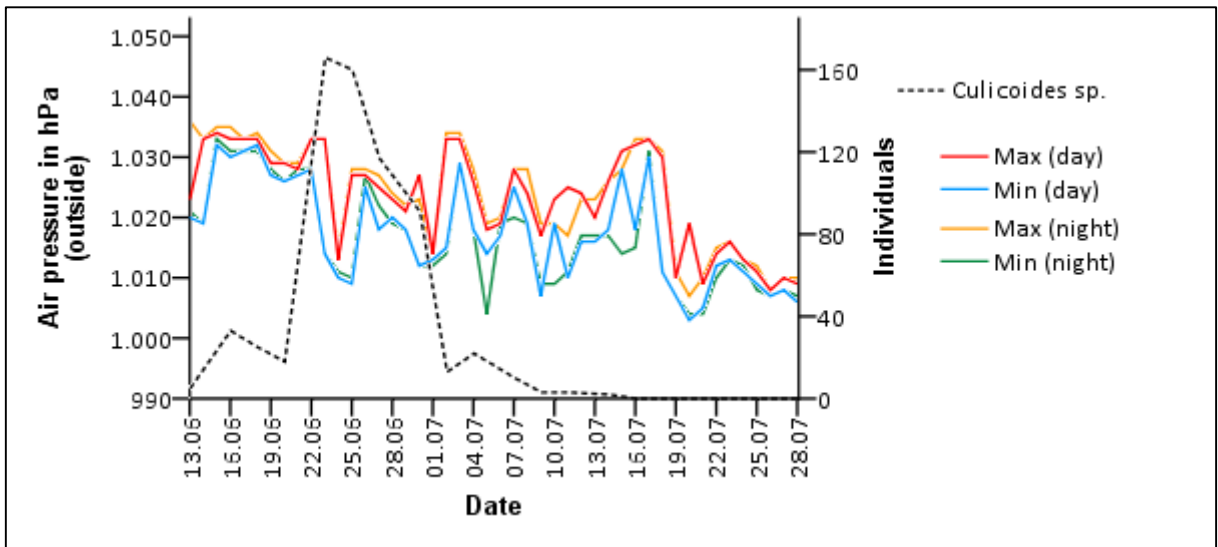


Fig. 23: Development of the air pressure during the experiment. The dotted line represents the total catch of *Culicoides sp.* as a reference.

### 3.10 Wind speed

The wind had a speed between 0.2 m/s and 4.9 m/s during the experiment. (Tab. 2). While the wind was very fluctuating at day the wind speed at night was relatively stable except some separate peaks between June 13 and June 21 as well as on July 1.

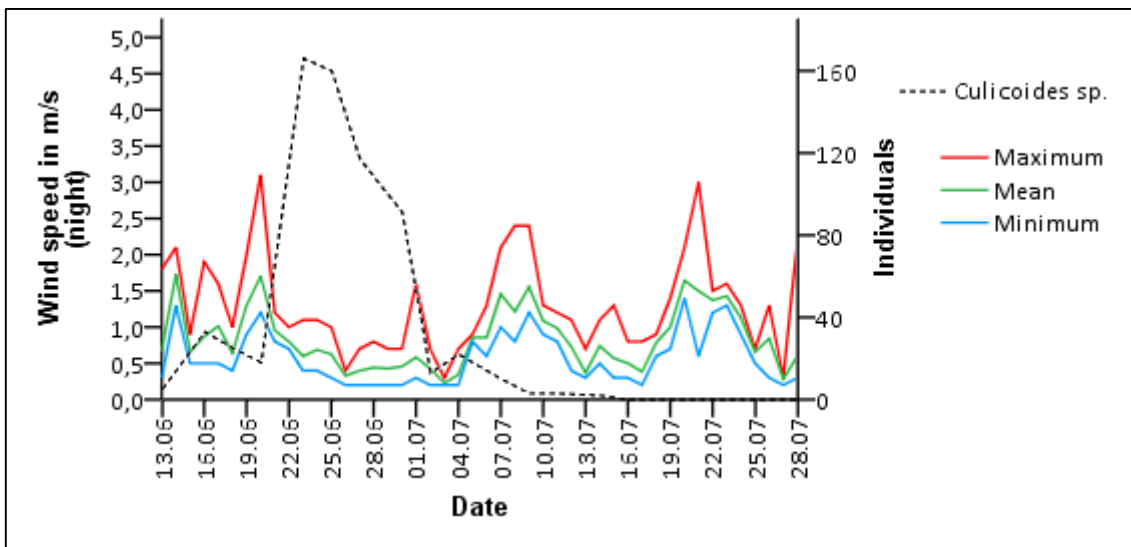


Fig. 24: Development of the wind speed during the night over the time of the experiment. The dotted line represents the total catch of *Culicoides sp.* as a reference.

### 3.11 General catch

A total of 668 *Culicoides* could be caught during the experiment. 462 of them belonged to the species *C. chiopterus*, 198 belonged to the species *C. dewulfi*. Eight individuals could not be determined because they were too damaged for further investigations. The overall distribution of *Culicoides* was very uneven - 22 of the 40 eclectors had a total catch of maximal ten *Culicoides sp.* individuals. The main emergence took place between June 20 and July 2 nevertheless there were two smaller peaks on June 16 respectively July 4 (Fig. 25). The emergence of *C. dewulfi* occurred later during this period, mainly induced by the eclectors 6D, 9C, 10C and 10D that made 72 % of the total *C. dewulfi* catch (Fig. 26).

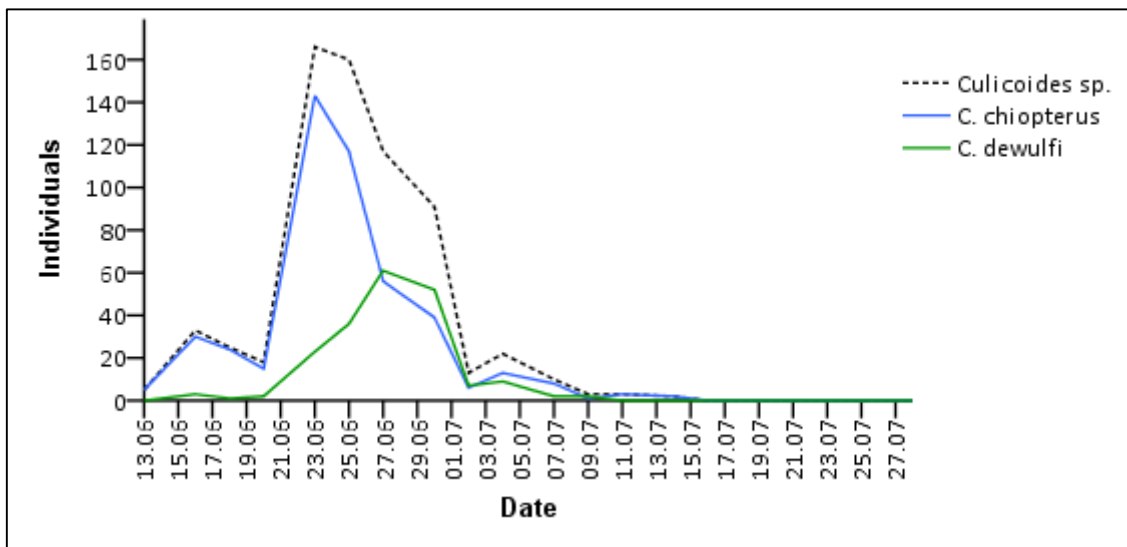
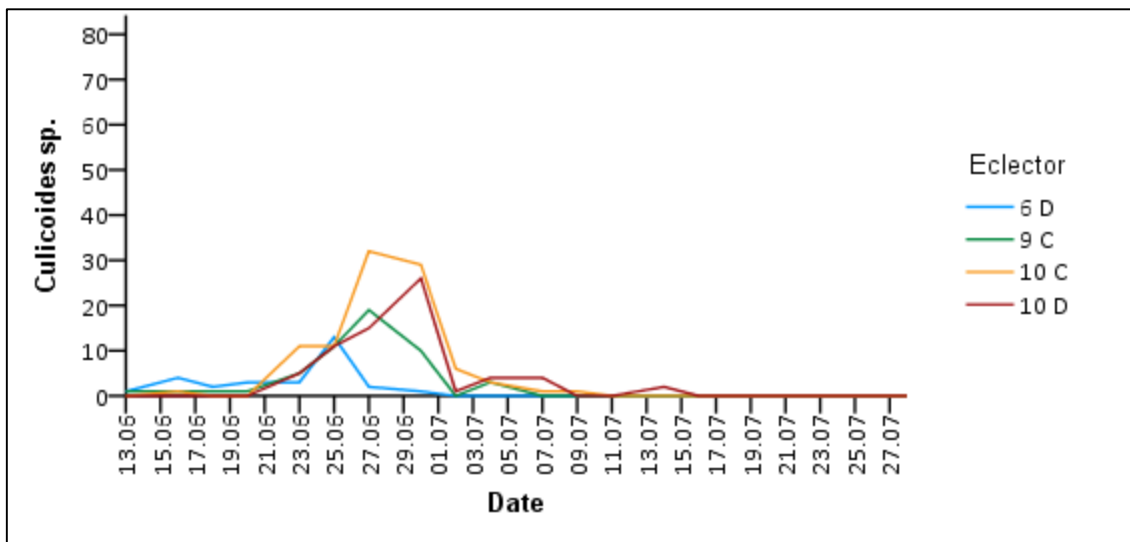


Fig. 25: Development of the general emergence during the experiment. A= white box, B = white funnel, C = black box, D = black funnel.

Because of the often small catch of the single eclectors the determination of sex ratios was difficult and resulted in wide ranges. Nevertheless there was a general tendency towards a higher share of females (Tab. 3). Moreover, the sex ratio ( $\text{♀}/\text{♂}$ ) of *C. dewulfi* was up to 14.0 respectively 22.5 for the eclectors 9C and 10D. Overall, the sex ratio for this species was 4.5.



**Fig. 26:** Emergence of the eclectors 6D, 9C, 10C and 10D that made 72 % of the total *C. dewulfi* catch. In contrast to most of the other eclectors these ones did not start with a distinct peak but slowly increased in catch.

**Tab. 3:** Sex ratio of the determined species based on the catch of all eclectors.

|                       | Total | Females | Males | Sex ratio (♀/♂) |
|-----------------------|-------|---------|-------|-----------------|
| <b>Culicoides sp.</b> | 668   | 454     | 214   | 2.12            |
| <b>C. chiopterus</b>  | 462   | 290     | 172   | 1.69            |
| <b>C. dewulfi</b>     | 198   | 162     | 36    | 4.5             |

### 3.12 Catch per type, shape and color

When investigating the emergence per type it was noticeable that there were several successful but no outstanding groups for *C. chiopterus* (Fig. 27 II). However, the tendency towards type C and type D was clearly visible. Regarding to *C. dewulfi* the same tendency existed, nevertheless it was more distinct. A One-Way ANOVA found both tendencies statistically proved, also for *C. chiopterus* (Tab. 4). The only exception were the *C. dewulfi* males.

**Tab. 4:** Results of the One-Way ANOVA for the test of tendencies towards eclector types.

|      | Culicoides sp. | C. chiopterus. | C. dewulfi | Culicoides sp. females | C. chiopterus females | C. dewulfi females | Culicoides sp. males | C. chiopterus males | C. dewulfi males |
|------|----------------|----------------|------------|------------------------|-----------------------|--------------------|----------------------|---------------------|------------------|
| Sig. | 0.000          | 0.000          | 0.024      | 0.000                  | 0.000                 | 0.025              | 0.000                | 0.003               | 0.080            |

Also statistically significant was the correlation between the amount of catch and the color (Tab. 5, Tab. 6, Independent samples t-test). However, the *C. dewulfi* males were an exception because they were slightly above the limit of  $p < 0.05$ . A correlation between the amount of catch and the shape (Tab. 5) could only be proved for the females of *C. chiopterus* (Independent samples t-test, Tab. 7).

**Tab. 5:** Catch per type, color and shape.

|                      | Type A | Type B | Type C | Type D | Ratio black/ white | Ratio box / funnel |
|----------------------|--------|--------|--------|--------|--------------------|--------------------|
| Culicoides sp.       | 72,0   | 95,0   | 322,0  | 179,0  | 3,0                | 1,4                |
| <i>C. chiopterus</i> | 54,0   | 81,0   | 225,0  | 102,0  | 2,4                | 1,5                |
| <i>C. dewulfi</i>    | 18,0   | 14,0   | 91,0   | 75,0   | 5,2                | 1,2                |

**Tab. 6:** Results of the independent samples T-Test that tested the tendency towards black or white.

|                 | Culicoides sp. | <i>C. chiopterus</i> . | <i>C. dewulfi</i> | Culicoides sp. females | <i>C. chiopterus</i> females | <i>C. dewulfi</i> females | Culicoides sp. males | <i>C. chiopterus</i> males | <i>C. dewulfi</i> males |
|-----------------|----------------|------------------------|-------------------|------------------------|------------------------------|---------------------------|----------------------|----------------------------|-------------------------|
| Sig. (2-tailed) | 0.000          | 0.001                  | 0.003             | 0.000                  | 0.001                        | 0.002                     | 0.001                | 0.003                      | 0.053                   |

**Tab. 7:** Results of the independent samples T-Test that tested the tendency towards funnel- or box-shape.

|                 | Culicoides sp. | <i>C. chiopterus</i> . | <i>C. dewulfi</i> | Culicoides sp. females | <i>C. chiopterus</i> females | <i>C. dewulfi</i> females | Culicoides sp. males | <i>C. chiopterus</i> males | <i>C. dewulfi</i> males |
|-----------------|----------------|------------------------|-------------------|------------------------|------------------------------|---------------------------|----------------------|----------------------------|-------------------------|
| Sig. (2-tailed) | 0.148          | 0.085                  | 0.653             | 0.161                  | 0.047                        | 0.750                     | 0.221                | 0.328                      | 0.439                   |



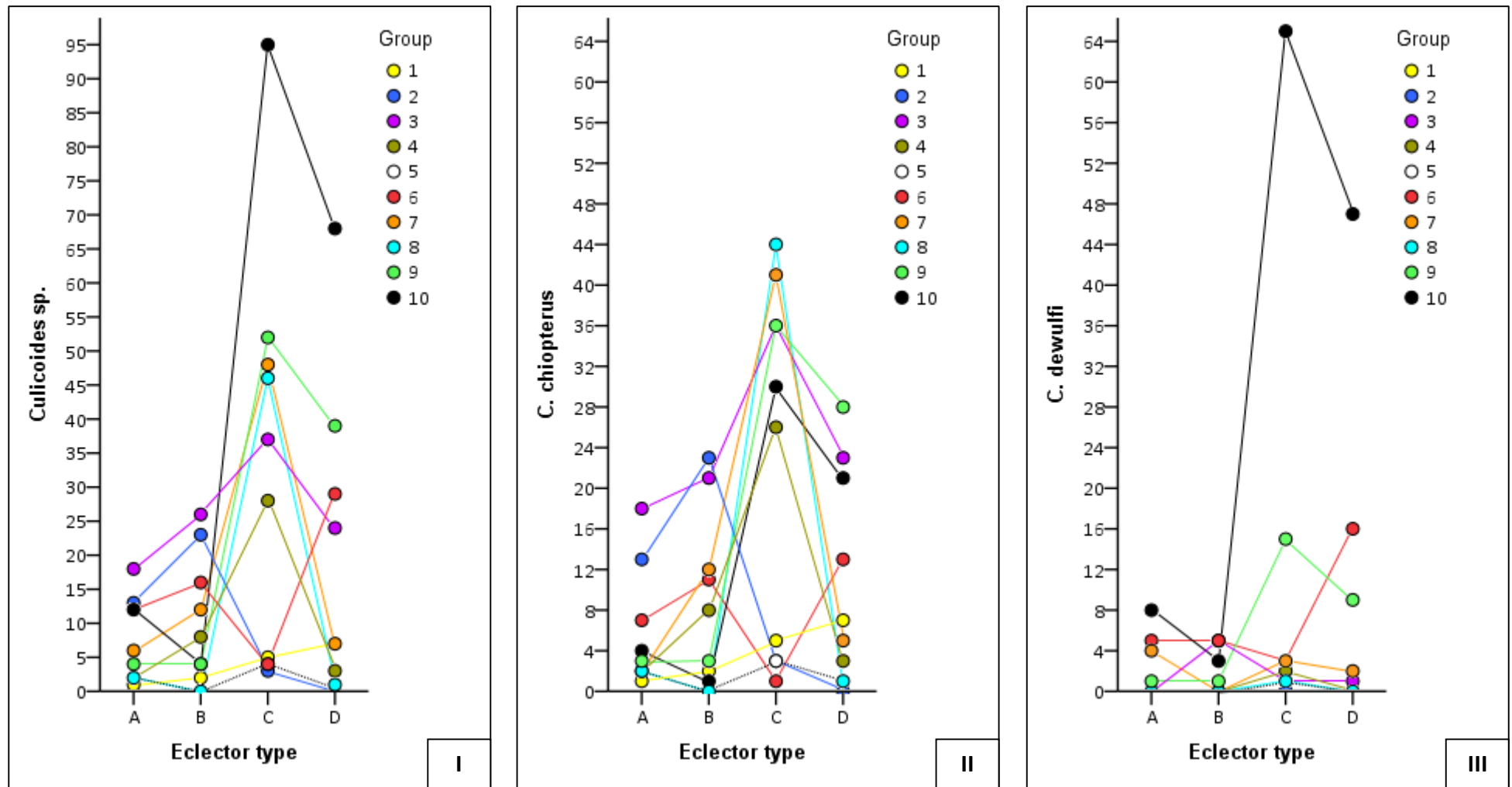


Fig. 27: Emergence of *Culicoides* sp. (I) respectively the two identified species *C. chiopterus* (II) and *C. dewulfi* (III). The points represent the total catch of the corresponding eclector. Due to the low emergence of some electors are there several overlaps of points, especially in the range between one and five individuals. The emergence of these electors can be inferred by the colored lines that also show the general trends.

## 4 Discussion

### 4.1 The forming of a specific microclimate inside the eclectors

Many observations and results of this thesis can be explained when assuming that the nearly closed structure of the used eclectors led to a specific microclimate inside them. As the temperature results imply there was a warming of the eclectors presumably caused by the restricted gas exchange through the aeration windows (Tab. 2). Because of the warming the salt solution inside the collection containers evaporated more and more in the course of the day. On the one hand, this led to a minimal but maybe important cooling of the eclectors because thermal energy was consumed. On the other hand the air humidity accumulated over the time of the experiment (Fig. 20). As a consequence there was more condensed water during the nights that may have cooled the eclectors through a combination of heat conduction and wind (Fig. 16).

### 4.2 The emergence of *C. chiopterus* and *C. dewulfi*

To date there are no studies that focused directly on the preferences of the two determined species. Therefore, a comparison of the breeding conditions with the preferences of the Australian *C. brevitarsis* may give the best results. *C. brevitarsis* was found to emerge from 17 °C to 36 °C with an temperature optimum between 25 °C and 36 °C (Bishop *et al.* 1996b). Another study set even more concrete limits, in detail a range from 26 °C to 33 °C (Allingham 1991). These temperatures were reached during the day (Tab. 2). Should the North European species *C. chiopterus* and *C. dewulfi* have slightly lower temperature preferences than the Australian species, the eclectors would have provided optimal temperatures.

Surprisingly, the temperature maxima that occurred during the days seemed not to harm the immature *Culicoides*. For example, the cow pat sample of eclector 3B reached 38.5 °C on June 15 (Fig. 13 I) but the emergence occurred continuous until June 27 with a peak on June 25. The temperature at the top was even higher and exceeded 50 °C. This implies that *C. chiopterus* and *C. dewulfi* have to be robust against high temperatures. When also taking in account that the nightly temperatures were far below the temperatures during the day (Tab. 2, Fig. 16) a general temperature tolerance of both species can be assumed.

The fast reaction of the occurred emergence to the temperature drops on June 16 and June 20 (Fig. 13, Fig. 18) accords to the findings of Bishop *et al.* (1996b) who found that the emergence can occur within 24 hours after the temperature reached an optimal value. The duration of the emergence period (the main peak includes 10-12 days) as well as the emergence in peaks was without appreciable features and accorded to several other studies about *Culicoides* (Akey, Potter & Jones 1978; Vaughan & Turner 1987; Allingham 1991; Bishop *et al.* 1996b; Veronesi *et al.* 2009; Ninio *et al.* 2011).

When investigating the conditions inside the eclectors concerning their suitability for adult *Culicoides*, especially the high air humidity was positive for their survival (Murray 1991; Mellor *et al.* 2000; Kirkeby *et al.* 2013). The few hours during this experiment where the relative humidity dropped below 30 % occurred during midday and in the afternoon - out of the usual activity time of *Culicoides* during sunrise and sunset (Griffioen *et al.* 2011; Ayllón *et al.* 2014). Because the lack of references the influence of the nightly temperatures can only be estimated. However because no dead *Culicoides* were found outside the collection containers it can be assumed that the temperatures were high enough to allow all emerged adults to fly towards the top. Wind speed and rainfall, the two other important factors for the activity of adult *Culicoides* (Mellor *et al.* 2000; Kirkeby *et al.* 2013) were indeed measured but if they had an effect on activity or emergence it was not strong enough to be visible.

All in all there is only one result of this thesis that has no very probable explanation: the sex ratio. It is very high (Tab. 3) and opposites for example Thompson *et al.* (2013) who compared the sex ratio of *Culicoides* in different substrates. Although this study only compared values of the whole *Obsoletus* group (a taxonomic unit that includes the relative species *C. obsoletus*, *C. scoticus*, *C. chiopterus* and *C. dewulfi*), the differences are distinct. In the experiment of Thompson *et al.* (2013) females that emerged from cow dung only made 34.9 % of the catch. In this study their share was about 63 % to 82 %, depending of the species.

A temperature dependence of the sex ratio is uncertain, whereat Bishop *et al.* (1996b) quoted that higher temperatures resulted in a higher share of females in *C. brevitarsis*. For example, the eclectors 10C and 10D had both an extreme high sex ratio ( $\text{♀}/\text{♂}$ ) of 14.00 respectively 22.5 although the temperature inside the samples were clearly higher inside 10C (Fig. 14). Other eclectors with high sex ratios can be found in all types and

could not be graded after temperature values. Nevertheless it has to be said again that only 12 of the eclectors were equipped with loggers so that a comparison consulting the temperature only has a limited database. At last, a color dependence of the sex ratio cannot be assumed without reservation for the same reason as the uncertain temperature dependence - eclectors with high sex ratios can be found in all types.

### **4.3 Differences between the types**

The described microclimate occurred within all eclectors, regardless of color or shape. Moreover the differences during the nights were minimal within the different groups and therefore between the single eclector types. Also the shape of the eclectors was only significant for the females of *C. chiopterus* (Tab. 7) whereat the p-value was only slightly below the 0.05-limit. Nevertheless, the catch success varied extremely between the eclectors (Fig. 27) and the distribution to the separate types was significant (Tab. 4). In the end only two possible reasons for these differences remain: The differences between the eclectors during the day and their different color.

When comparing the differences during the day step by step, neither the air humidity (Fig. 22) nor the temperature at the top (Fig. 17) or the side (Fig 17) revealed differences strong enough to be an explanation. Concerning the temperature inside the samples (Fig. 14) there were conspicuous eclectors. Nevertheless, even if one generalizes the differences they are not transferable. For example the type D eclectors had a lower overall temperature than the ones of type C or B. Nevertheless the order of the most catch was  $C > D > B$  (Fig. 27).

Finally, only the color can explain the tendency towards type C and D (Tab. 6, Fig. 27). In detail, an increased heating of the black eclectors due to an increased absorption of light could not be observed in this thesis (Fig. 14, Fig. 15, Fig. 17). Therefore, the light intensity has to be the deciding parameter.

How it exactly the light intensity influenced the emergence and catch has to be figured out in further studies, at this point it is only possible to make presumptions. The easiest explanation would be the positive phototaxis of *Culicoides* adults. Because the walls inside the black eclectors were darker individuals were more likely to fly towards the opening at the top. A different phototaxis of the two determined species would also explain why *C. dewulfi* emerged mainly from the black eclectors. However one have to

keep in mind that no individuals could be found in other parts than the collection containers during the experiment, although there was no explicit control to prove this observation. The different light intensities could also have had an influence on the microorganisms the immature *Culicoides* fed on, on the overall production of organic matter or the chemical composition of the cow pat samples. However such an influence cannot be investigated by using the data of this thesis.

#### **4.4 Conclusions and suggestions for further studies**

When summing up all information of this thesis, five main conclusions can be drawn:

1.) The different eclector types caught different amounts of *Culicoides*, the types C and D had the most success. 2.) The difference of color and therefore in light intensity was the deciding parameter. 3.) The closed structure of the eclectors provided a specific microclimate inside the eclectors. 4.) The development of the emergence was dependent from the temperature inside the eclectors. 5.) Both *C. chiopterus* and *C. dewulfi* seemed to be very tolerant to temperature extremes.

The main result of this thesis – the dependence on color – is an important point for the development of standardized and efficient emergence traps respectively an experimental system comparable to the one of *C. brevitarsis*.

However, the newly gained information about the microclimate that could form inside eclectors is only useful for closed designs like plastic buckets (Uslu & Dik 2010; Thompson *et al.* 2013). Tent-like traps like they were introduced by Pajor (1987) are likely to show other characteristics due to better gas exchange.

To investigate these traps would be a possible next step. An alternative would be to repeat the experiment conducted in this thesis with some improvements. For example, fresh cow dung could be collected and mixed to get standardized samples. Additional parameters like pH, mineral constituents or electrical conductivity could be measured to investigate if they change during the experiment. Bycatch could be stored and determined to test if interactions are possible. Hay could be mixed in the used samples because dung containing hay was found to be a more productive habitat for *Culicoides* than loose animal droppings (Koenraad *et al.* 2014). This list could be further continued and many more points could be discussed based on the data of this thesis. Nevertheless, this would go too far for the size of this thesis.

## 5 References

- Akey D.H., Potter H.W. & Jones R.H. (1978) Effects of Rearing Temperature and Larval Density On Longevity Size and Fecundity in the Biting Gnat *Culicoides variipennis*. *Annals-of-the-Entomological-Society-of-America*. 1978; **71**, 411–418.
- Allingham P.G. (1991) Effect of temperature on late immature stages of *Culicoides brevitarsis* (Diptera: Ceratopogonidae). *Journal of medical entomology* **28**, 878–81.
- Ansari M.A., Pope E.C., Carpenter S., Scholte E.-J. & Butt T.M. (2011) Entomopathogenic fungus as a biological control for an important vector of livestock disease: the *Culicoides* biting midge. *PloS one* **6**, e16108.
- Ayllón T., Nijhof A.M., Weiher W., Bauer B., Allène X. & Clausen P.-H. (2014) Feeding behaviour of *Culicoides* spp. (Diptera: Ceratopogonidae) on cattle and sheep in northeast Germany. *Parasites & vectors* **7**, 34.
- Backer J. a & Nodelijk G. (2011) Transmission and control of African horse sickness in The Netherlands: a model analysis. *PloS one* **6**, e23066.
- Bishop A.L. AL, McKenzie H.J.H., Barchia I.M. & Harris A.M. (1996a) Effect of temperature regimes on the development, survival and emergence of *Culicoides brevitarsis* Kieffer (Diptera: Ceratopogonidae) in bovine dung. *Australian Journal of Entomology* **35**, 361–368.
- Bishop A.L., Mckenzie H.J., Barchia M. & Harris A.M. (1996b) Effect of Temperature Regimes on the Development , Survival and Emergence of *Culicoides brevitarsis* Kieffer ( Diptera : Ceratopogonidae ) in Bovine Dung. 361–368.
- Bishop A.L., McKenzie H.J., Spohr L.J. & Barchia I.M. (2005) Interactions between dung beetles (Coleoptera: Scarabaeidae) and the arbovirus vector *Culicoides brevitarsis* Kieffer (Diptera: Ceratopogonidae). *Australian Journal of Entomology* **44**, 89–96.
- Blanton F.R. & Wirth W.W. (1979) *The Sand flies (Culicoides) of Florida (Diptera: Ceratopogonidae)*. Florida Department of Agriculture and Customer Services, Gainesville, Florida.
- Campbell J.A. & Pelham-Clinton E.C. (1960) A *Taxonomic Review of the British Species of "Culicoides" Latreille (Diptera, Ceratopogonidae)*. Royal Society of Edinburgh, Edinburgh.
- Carpenter S., Groschup M.H., Garros C., Felipe-Bauer M.L. & Purse B. V (2013) *Culicoides* biting midges, arboviruses and public health in Europe. *Antiviral research* **100**, 102–13.
- Carpenter S., Mellor P.S. & Torr S.J. (2008) Control techniques for *Culicoides* biting midges and their application in the U.K. and northwestern Palaearctic. *Medical and veterinary entomology* **22**, 175–87.
- Casati S., Racloz V., Delécolle J.C., Kuhn M., Mathis a, Griot C., et al. (2009) An investigation on the *Culicoides* species composition at seven sites in southern Switzerland. *Medical and veterinary entomology* **23**, 93–8.
- Conraths F.J., Gethmann J.M., Staubach C., Mettenleiter T.C., Beer M. & Hoffmann B. (2009) Epidemiology of bluetongue virus serotype 8, Germany. *Emerging infectious diseases* **15**, 433–435.
- Conraths, F., Eschbaumer, M., Freuling, C., Gethmann, J., Hoffmann, B., Kramer, M., Probst, C., Staubach, C., Beer M. (2012) Arthropods as Vectors of Emerging Diseases. In: Parasitology Research Monographs, (Ed. H. Mehlhorn), p. 126. Springer Berlin Heidelberg, Berlin, Heidelberg.
- Doceul V., Lara E., Sailleau C., Belbis G., Richardson J., Bréard E., et al. (2013) Epidemiology, molecular virology and diagnostics of Schmallenberg virus, an emerging orthobunyavirus in Europe. *Veterinary research* **44**, 31.
- Dukes J.C. & Axtell R.C. (1976) Residual effectiveness of insecticide-treated screens for control of biting midges, *Culicoides furens* (Poey) (Diptera: Ceratopogonidae). *Mosquito News* **36**, 4–7.
- Dyce A.L. & Marshall B.D. (1989) An early record of *Culicoides* species (Diptera: Ceratopogonidae) developing in the dung of game animals in southern Africa. *The Onderstepoort journal of veterinary research* **56**, 85–6.
- European Food Safety Authority (2007) Scientific Opinion of the Scientific Panel on Animal Health and Welfare on the EFSA Selfmandate on bluetongue origin and occurrence. *The EFSA Journal* **480**, 1–20.

- Foxi C. & Delrio G. (2010) Larval habitats and seasonal abundance of *Culicoides* biting midges found in association with sheep in northern Sardinia, Italy. *Medical and Veterinary Entomology* **24**, 199–209.
- González M., Baldet T., Delécolle J.C., Romón P. & Goldarazena A. (2013) Monitoring of *Culicoides* Latreille (Diptera: Ceratopogonidae) After Btv Outbreaks, in Sheep Farms and Natural Habitats from the Basque Country (Northern Spain).
- Griffioen K., van Gemst D.B.J., Pieterse M.C., Jacobs F. & Sloet van Oldruitenborgh-Oosterbaan M.M. (2011) *Culicoides* species associated with sheep in the Netherlands and the effect of a permethrin insecticide. *Veterinary journal (London, England : 1997)* **190**, 230–5.
- Harrup L.E., Gubbins S., Barber J., Denison E., Mellor P.S., Purse B. V, *et al.* (2014) Does covering of farm-associated *Culicoides* larval habitat reduce adult populations in the United Kingdom? *Veterinary parasitology* **201**, 137–45.
- Harrup L.E., Purse B. V, Golding N., Mellor P.S. & Carpenter S. (2013) Larval development and emergence sites of farm-associated *Culicoides* in the United Kingdom. *Medical and veterinary entomology* **27**, 441–9.
- Hoffmann B., Sasserath M., Thalheim S., Bunzenthal C., Strebelow G. & Beer M. (2008) *Bluetongue virus serotype 8 reemergence in Germany, 2007 and 2008*.
- Kettle D.S. (1962) The Bionomics and Control of *Culicoides* and *Leptoconops* (Diptera, Ceratopogonidae = Heleidae). *Annual Review of Entomology* **7**, 401–418.
- Kettle D.S. & Lawson J.W.H. (1952) The early Stages of British Biting Midges *Culicoides* Latreille (Diptera: Ceratopogonidae) and allied Genera. *Bulletin of Entomological Research* **43**, 421.
- Kirkeby C., Bødker R., Stockmarr A. & Enøe C. (2009) Association between land cover and *Culicoides* (Diptera: Ceratopogonidae) breeding sites on four Danish cattle farms. *Entomologica Fennica* **20**, 228–232.
- Kirkeby C., Bødker R., Stockmarr A. & Lind P. (2013) Spatial abundance and clustering of *Culicoides* (Diptera: Ceratopogonidae) on a local scale. *Parasites & vectors* **6**, 43.
- Koenraadt C.J., Balenghien T., Carpenter S., Ducheyne E., Elbers A.R., Fife M., *et al.* (2014) Bluetongue, Schmallenberg - what is next? *Culicoides*-borne viral diseases in the 21st Century. *BMC veterinary research* **10**, 77.
- Lievaart-Peterson K., Luttikholt S.J.M., Van den Brom R. & Vellema P. (2012) Schmallenberg virus infection in small ruminants – First review of the situation and prospects in Northern Europe. *Small Ruminant Research* **106**, 71–76.
- Lühken R., Kiel E. & Steinke S. (2014a) Impact of mechanical disturbance on the emergence of *Culicoides* from cowpats. *Parasitology research* **113**, 1283–7.
- Lühken R., Steinke S., Wittmann A. & Kiel E. (2014b) Impact of flooding on the immature stages of dung-breeding *Culicoides* in Northern Europe. *Veterinary parasitology* **205**, 289–94.
- Mehlhorn H., Schmahl G., D’Haese J. & Schumacher B. (2008a) Butox 7.5 pour on: a deltamethrin treatment of sheep and cattle: pilot study of killing effects on *Culicoides* species (Ceratopogonidae). *Parasitology research* **102**, 515–518.
- Mehlhorn H., Walldorf V., Klimpel S., Jahn B., Jaeger F., Eschweiler J., *et al.* (2007) First occurrence of *Culicoides* obsoletus-transmitted Bluetongue virus epidemic in Central Europe. *Parasitology research* **101**, 219–228.
- Mehlhorn H., Walldorf V., Klimpel S., Schaub G., Kiel E., Focke R., *et al.* (2009a) Bluetongue disease in Germany (2007-2008): monitoring of entomological aspects. *Parasitology research* **105**, 313–9.
- Mehlhorn H., Walldorf V., Klimpel S. & Schmahl G. (2008b) Outbreak of bluetongue disease (BTD) in Germany and the danger for Europe. *Parasitology research* **103 Suppl**, S79–S86.
- Mehlhorn H., Walldorf V., Klimpel S., Schmahl G., Al-Quraishy S., Walldorf U., *et al.* (2009b) Entomological survey on vectors of Bluetongue virus in Northrhine-Westfalia (Germany) during 2007 and 2008. *Parasitology research* **105**, 321–9.
- Meiswinkel R., Venter G. & Nevill E.M. (2004) Vectors: *Culicoides* spp. In: *Infectious Diseases of Livestock*. pp. 93–136.
- Mellor P.S., Boorman J. & Baylis M. (2000) *Culicoides* biting midges: their role as arbovirus vectors. *Annual review of entomology* **45**, 307–40.
- Mellor P.S. & Hamblin C. (2004) African horse sickness. *Veterinary research* **35**, 445–66.
- Murray M. (1991) The Seasonal Abundance of Female Biting-Midges, *Culicoides*-*Brevitarsis* Kieffer (Diptera, Ceratopogonidae), in Coastal South-Eastern Australia. *Australian Journal of Zoology* **39**, 333.

- Nielsen S.A. & Kristensen M. (2011) Morphological and molecular identification of species of the *Obsoletus* group (Diptera: Ceratopogonidae) in Scandinavia. *Parasitology research* **109**, 1133–41.
- Ninio C., Augot D., Dufour B. & Depaquit J. (2011) Emergence of *Culicoides obsoletus* from indoor and outdoor breeding sites. *Veterinary parasitology* **183**, 125–9.
- Pajor I.T. (1987) A collapsible, semi-automatic, tent-type, emergence trap, suitable for sampling *Culicoides* (Diptera: Ceratopogonidae) from a wide range of habitats. *The Onderstepoort journal of veterinary research* **54**, 99–101.
- Persson Vinnersten T.Z., Lundström J.O., Schäfer M.L., Petersson E. & Landin J. (2010) A six-year study of insect emergence from temporary flooded wetlands in central Sweden, with and without Bti-based mosquito control. *Bulletin of entomological research* **100**, 715–25.
- Root D.S. & Gerhardt R.R. (1990) SEASONAL EMERGENCE PATTERNS OF CULICOIDES (DIPTERA: CERATOPOGONIDAE) IN EASTERN TENNESSEE '.
- Saegerman C., Berkvens D. & Mellor P.S. (2008) Bluetongue epidemiology in the European Union. *Emerging infectious diseases* **14**, 539–44.
- Schmahl G., Klimpel S., Walldorf V., Schumacher B., Jatzlau A., Al-Quraishy S., *et al.* (2009) Effects of permethrin (Flypor) and fenvalerate (Acadrex60, Arkofly) on *Culicoides* species-the vector of Bluetongue virus. *Parasitology research* **104**, 815–20.
- Steinke S., Lühken R. & Kiel E. (2014) Assessment of the abundance of *Culicoides chiopterus* and *Culicoides dewulfi* in bovine dung: A comparison of larvae extraction techniques and emergence traps. *Veterinary parasitology* **205**, 255–62.
- Thompson G.M., Jess S. & Murchie A.K. (2013) Differential emergence of *Culicoides* (Diptera: Ceratopogonidae) from on-farm breeding substrates in Northern Ireland. *Parasitology* **140**, 699–708.
- Toussaint J., Sailleau C., Mast J., Houdart P., Czaplicki G., Demeestere L., *et al.* (2007) Bluetongue in Belgium, 2006. *Emerging infectious diseases* **13**, 614–616.
- Uslu U. & Dik B. (2010) Chemical characteristics of breeding sites of *Culicoides* species (Diptera: Ceratopogonidae). *Veterinary Parasitology* **169**, 178–184.
- Uslu U. & Dik B. (2007) Description of breeding sites of *Culicoides* species (Diptera: Ceratopogonidae) in Turkey. *Parasite (Paris, France)* **14**, 173–7.
- Vaughan J.A. & Turner E.C. (1987) Development of immature *Culicoides variipennis* (Diptera: Ceratopogonidae) from Saltville, Virginia, at constant laboratory temperatures. *Journal of medical entomology* **24**, 390–395.
- Velthuis A.G.J., Saatkamp H.W., Mourits M.C.M., de Koeijer A.A. & Elbers A.R.W. (2010) Financial consequences of the Dutch bluetongue serotype 8 epidemics of 2006 and 2007. *Preventive veterinary medicine* **93**, 294–304.
- Veronesi E., Venter G.J., Labuschagne K., Mellor P.S. & Carpenter S. (2009) Life-history parameters of *Culicoides (Avaritia) imicola* Kieffer in the laboratory at different rearing temperatures. *Veterinary parasitology* **163**, 370–3.
- Wilson a, Carpenter S., Gloster J. & Mellor P. (2007) Re-emergence of bluetongue in northern Europe in 2007. *The Veterinary record* **161**, 487–9.

## Acknowledgements

Thanks to Kathy and Katja, Tf and Tb.



Hiermit versichere ich, dass ich diese Arbeit selbständig verfasst und keine anderen als die angegebenen Quellen und Hilfsmittel benutzt habe. Außerdem versichere ich, dass ich die allgemeinen Prinzipien wissenschaftlicher Arbeit und Veröffentlichung, wie sie in den Leitlinien guter wissenschaftlicher Praxis der Carl von Ossietzky Universität Oldenburg festgelegt sind, befolgt habe.

---

Felix Kroischke